



PRODUCT CATALOGUE

UNLEASH THE POWER

PoolSystems
pool • spa • lifestyle™





ABOUT US

Pool Systems is Australia's leading distributor of swimming pool and spa products. Established in 1983, we supply pool equipment, chemicals, spare parts and leisure products to a broad range of trade customers in Australia, New Zealand, Oceania, the USA and Europe.

Our Head Office is in Brisbane, where we also have our largest distribution centre. Our other distribution centres are located in Sydney, Gold Coast and Melbourne. These locations enable fast and efficient supply of our extensive product range numbering numbers more than 7,000+. Our international customer logistics team facilitates export shipments to all corners of the globe.

Pool Systems represents and sells many of the industry's premier brands, providing coordinated marketing support and broad market opportunity. In addition our own brands – Aussie Gold, Swimsafe, Life and Swimsportz are the leaders in their category. Adding value to our and customers' business is our highly experienced Commercial team, who are product development and sourcing specialists. Our national business is driven through a large team of in-field sales and key account managers and these are supported by centralized customer service and local logistics teams.

Our industry leadership has been earned through customer focus, product quality and innovation in both product and promotion. We strive to excel.



BRANDS & PRODUCTS

As the leading wholesaler to the pool and spa industry, we are able to offer a broad range of brands across all product categories. Among these are our own brands which have been developed to meet strategic market profiles.



Aussie Gold™, our premium level brand is the benchmark in the segment of pool maintenance and accessories. Manufactured using high quality, heavy duty materials and with an extended warranty, this brand is the market leader in its represented categories.



The PoolStyle™ product range are professional grade tools built for long-lasting performance. All products are designed with functional elements and all components are of the highest of quality.



Designed for every day use, All Seasons™ delivers strong reliable and real value products.

TABLE OF CONTENTS

Cleaning Equipment

6 - 15

| | |
|--|----|
| Aussie Gold Brushes, Pool Brooms, Leaf Shovels & Leaf Rakes..... | 6 |
| Aussie Hold Leaf Scoops & Vacuum Heads..... | 7 |
| Aussie Gold Leaf Bagger & Leaf Canister..... | 8 |
| All Seasons Leaf Rake, Pool Brooms & Vacuum Heads..... | 8 |
| Pro Series Leaf Rake, Pool Broom & Vacuum Heads | 9 |
| Telescopic Handles..... | 9 |
| Vacuum Systems..... | 10 |
| Automatic Pool Cleaners..... | 11 |
| Handover Kits..... | 12 |
| Vacuum Hoses Automatic & Manual..... | 12 |

Water Testing

16 - 21

| | |
|--------------------------------------|----|
| Test kits & Spares..... | 16 |
| Waterlink Test Kits & Spin Disc..... | 16 |
| Test Solutions..... | 17 |
| Reagents, Test Strips & Tablets..... | 17 |
| Photometer Tablets..... | 19 |
| Photometers & Test Meters..... | 21 |

General Products

21 - 28

| | |
|---|----|
| Skimmers Socks..... | 21 |
| Floating Thermometers..... | 21 |
| Floating Dispensers, CPR Charts & Depth Marker Signs..... | 22 |
| Pumps & Filter Systems..... | 23 |
| General Maintenance..... | 23 |
| Miscellaneous..... | 23 |
| Repair Products & Plugs..... | 27 |
| Magna Latch..... | 28 |

Chemical Products

29 - 30

| | |
|--------------------------------|----|
| Restore Filter Cleaners..... | 29 |
| Clarifying Tablets..... | 29 |
| Crystal Cubes..... | 29 |
| Lubricant..... | 29 |
| Filter Sand & Glass Media..... | 30 |
| Stain Remover..... | 30 |
| Solutions..... | 30 |

Valves, Pipe & Fittings

31 - 37

| | |
|---------------------------------------|----|
| PVC Pipe & Fittings..... | 31 |
| Eyeballs..... | 33 |
| Safety Suctions & Air Injections..... | 34 |
| Valves..... | 35 |
| Ladder Parts..... | 37 |

Spare Parts

37 - 66

| | |
|--|----|
| Automatic Cleaner Parts..... | 37 |
| Pump & Skimmer Baskets..... | 40 |
| Filter Socks Discs..... | 42 |
| Cartridges..... | 43 |
| Flexible Connectors, Clamps, Gaskets & O-Rings.... | 55 |
| Lids Cartridges & Pump Lids..... | 56 |
| Deck Lids & Dress Rims..... | 57 |
| Main Drain Covers 7 Skimtrol Plates..... | 58 |
| Vacuum Plates..... | 59 |
| Transformers..... | 60 |
| Lighting Equipment, Spares & Pressure Gauges..... | 61 |
| Lenses, Rims & Mountings..... | 62 |
| Weir Doors..... | 63 |
| Weir Doors Spares..... | 64 |
| Vacuum Hose Spares..... | 64 |
| Cleaning Equipment Spares..... | 65 |
| Miscellaneous..... | 66 |



Algae Brushes

| | | |
|---|----------|---|
| 1 | CBK205-A | Algae Brush 6" Stainless steel bristles |
| 2 | CBK255-A | Algae Brush 10" Stainless steel bristles |
| 3 | CBK267-A | Algae Brush 10" All surface heavy duty nylon bristles |
| 4 | CBK225 | Multi-Purpose Brush |

Pool Brooms

| | | |
|---|----------|---|
| 1 | CBK458-A | Pool Broom – Super: 45cm 7.5cm width, 67% larger, ideal all surface broom with heavy duty nylon & PP bristles |
| 2 | CBK418-A | Pool Broom: 45cm, Crimped nylon bristle |



Leaf Shovels

Lifts up debris up and flicks it into a large receptacle net

| | | |
|---|----------|---|
| 1 | CRK541-A | Leaf Shovel – Super: Moulded frame high quality White net |
| 2 | CRK542-A | Leaf Shovel MKII: High quality White net |

Leaf Rakes

Removes surface and floor debris

| | | |
|---|----------|--|
| 1 | CRK553-A | Leaf Rake – Deluxe: Polyester net |
| 2 | CRS550 | Leaf Rake – Super: Unique moulded frame deep polyester net |



Leaf Scoops

| | | |
|---|----------|--|
| 1 | CSK555-A | Leaf Scoop – Deluxe: Deep polyester net |
| 2 | CSK584-A | Leaf Scoop – Moulded: Polyester net plus magnet moulded in frame |
| 3 | CSA500 | Extenda Scoop: 1.5m, 4 piece handle |



All Brush Vacuum Heads

| | | |
|---|----------|-----------------------|
| 1 | CVB501-A | Vacuum Head All Brush |
|---|----------|-----------------------|

Flexible Vacuum Head

| | | |
|---|----------|----------------------------|
| 2 | CVB550-A | Vacuum Head Flexible Brush |
|---|----------|----------------------------|

| | | |
|---|----------|--|
| 3 | CVF502-A | Vacuum Head Flexible: Non slip rubber wheels |
|---|----------|--|



Leaf Bagger

| | | |
|---|--------|-------------------------------|
| 1 | CCA254 | Leaf Bagger Australian Handle |
|---|--------|-------------------------------|

Leaf Canisters

| | | |
|---|--------|--|
| 1 | CLC730 | Pool Style Leaf Canister For automatic Suction Cleaners |
| 2 | CLC030 | Leaf Canister With Bag and Basket – Aussie Gold |

| | | |
|---|---------|--------------------------|
| 3 | AC-W530 | Hayward Canister - Large |
|---|---------|--------------------------|



All Seasons Leaf Rake & Pool Broom

| | | |
|---|--------|-------------------|
| 1 | CBA418 | Pool Broom – 45cm |
| 2 | CRA553 | Leaf Rake |

All Seasons Vacuum Heads

| | | |
|---|--------|-------------------------|
| 3 | CVA502 | Vacuum Head – Flexible |
| 4 | CVA501 | Vacuum Head – All-Brush |



Pro Series Range

Professional grade tools built for long-lasting performance. All products are designed with functional elements and all components are of the highest of quality.

Leaf Rake & Broom

| | | |
|---|--------|-------------------------|
| 1 | CRK793 | Pro Series Deluxe Rake |
| 2 | CBK798 | Pro Series Deluxe Broom |

Flexible & Commercial Vacuum Head

| | | |
|---|--------|--|
| 3 | CVF791 | Pro Series Deluxe Flexi Vac Head 14" |
| 4 | CVA700 | Pro Series Deluxe Commercial Vacuum Head 22" |

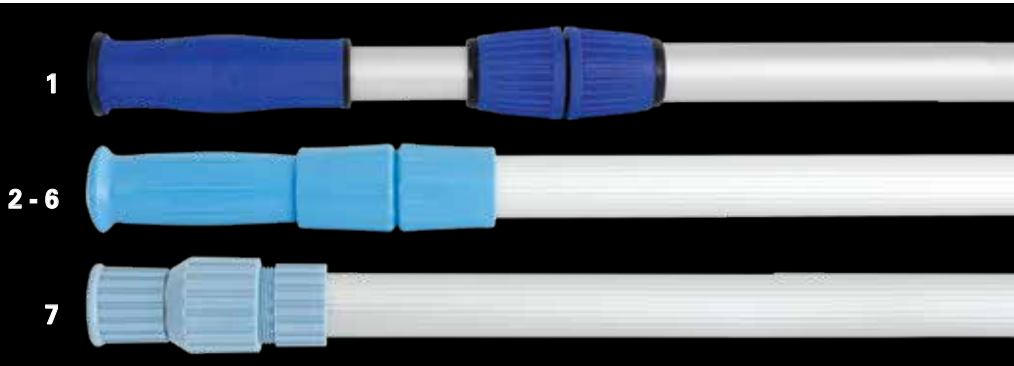

Telescopic Handles

| | | | |
|---|-------------|--|-------------|
| 1 | CTH718 | Pro Series Deluxe Pole 8ft -16ft | 2.4m – 4.8m |
| 2 | CTH104 | Aussie Gold Tele Handle 4-8ft External Cam | 1.2m – 2.4m |
| 3 | CTH110 | Aussie Gold Tele Handle 6-12ft External Cam | 1.8m – 3.6m |
| 4 | CTH118 | Aussie Gold Tele Handle 8-16ft External Cam | 2.4m – 4.8m |
| 5 | CTH124 | Aussie Gold Tele Handle 12-24ft External Cam | 3.6m – 7.2m |
| 6 | CTH132 | Aussie Gold Tele Handle 16-32ft External Cam | 4.8m – 9.6m |
| 7 | BR-TM8-16-M | Magnor Telepole 8-16' | 2.4m – 4.8m |

10 Cleaning Equipment | Vacuum Systems



Vektro Rechargeable Vacuum

Ideal for vacuuming small pools and spas, or spot cleaning of larger pools. Handheld or attaches to a telescopic pole (not included). Turns on with the press of a button and has a rechargeable lithium ION battery pack.

| | | |
|---|--------|-------------------------------------|
| 1 | CSV100 | Vektro T100 Rechargeable Spa Vacuum |
| 2 | CSV300 | Vektro T300 Rechargeable Vacuum |

Supa-Vac

The unique Supa-Vac design allows you to quickly clean or empty virtually any water fixture. ie. above ground and inground pools (steps and swimouts), spas, splashers and padding pools, fountains, ponds and ornamental water features.

| | | |
|---|--------|--|
| 1 | CSV005 | Supa-Vac: Complete with handle & hose |
| 2 | CSV040 | Supa-Vac Pool Maintenance Kit: Includes leaf scoop |



Supa-Vac

| | | |
|---|--------|------------------------------|
| 1 | CHZ205 | Drain Hose Supa-Vac 2.5m |
| 2 | CSV120 | Nozzle & Clip Supa-Vac |
| 3 | MFS310 | Filter Bag Supa-Vac - Single |

| | | |
|---|--------|------------------------------------|
| 4 | CSV625 | Life Spa Maintenance Kit |
| 5 | CSV505 | Paradise Spa Vacuum - Single |
| 6 | CSV506 | Paradise Spa Vacuum - Display of 6 |



Avenger Pool Cleaner

| | |
|--------|------------------------------------|
| AVG001 | Pool Cleaner Avenger – All Surface |
|--------|------------------------------------|

Avenger Pool Cleaner is the ultimate in automated pool cleaning. Simple to install, it features patented AutoPilot® buoyancy and steering control system that provides unrivalled manoeuvrability and superior performance. Designed to work in your pool effortlessly, the Avenger cleans, climbs and vacuums your pool like no other. This makes the Avenger the intelligent choice.

Hi-Grip™ foot offers superb wall climbing ability. The Avenger incorporates reliable everlast diaphragm technology giving quiet and dependable operation. Inclusive of 12 individual hose lengths. Unique interlocking ribbed cuffs for extra strength ensuring hose durability and longevity.

The SkimIt™ – Speed control elbow valve allows for precise water flow enabling Avenger to run at optimal performance.

Each Avenger Pool Cleaner includes:

- 1 x Pool Cleaner
- 1 x Auto Pilot Arm
- 12 x 1m Hose Lengths
- 1 x Hose Weight
- 1 x Speed Control Elbow Valve
- 1 x Deflector Wheel – Standard
- 1 x Hose Adaptor
- 1 x Flow Indicator
- 1 x Manual & Warranty Card



Titan Pool Cleaner

| | |
|--------|--------------------|
| CTC010 | Titan Pool Cleaner |
|--------|--------------------|

Titan Pool Cleaner is designed for the most demanding applications in all types of pool finishes. Using the flow created by your filter pump, it is simply connected to your skimmer vacuum plate to scrub and vacuum your pool floor and most walls. Installs in minutes & without tools.

Quickly attaches to your pool skimmer in minutes. It cleans using a true random-pattern coverage that ensures that every inch of your pool's floor is vacuumed thoroughly.

The step deflector means the cleaner operates in nearly any environment without getting stuck in one area of the pool. The adjustable by-pass valve allows for operation from small to large capacity filtration pumps.

The dual suction design of the Titan Pool Cleaner ensures your pump and filter is never starved of water and helps your equipment last longer. Every Titan Pool Cleaner come with 14 pieces of 80cm high quality spiral wound hoses.



Handover Kits

Aussie Gold Handover Kits are available for both inground and above-ground pools.

| | | | |
|--------|--------------------------|--------|--------------------------|
| CKP009 | Premier Kit Type 2 – 9m | CKP309 | Premier Kit Type 4 – 9m |
| CKP011 | Premier Kit Type 2 – 11m | CKP311 | Premier Kit Type 4 – 11m |
| CKP013 | Premier Kit Type 2 – 13m | CKP313 | Premier Kit Type 4 – 13m |
| CKP015 | Premier Kit Type 2 – 15m | CKP315 | Premier Kit Type 4 – 15m |

Type 2 contains: Premier 38mm Vacuum Hose, Leaf Rake, 4 in 1 Test Kit, Flexible Vacuum Head, Pool Broom 45cm, CPR Resuscitation Chart and Telescopic Handle.

Type 4 contains: Premier 38mm Vacuum Hose, Leaf Rake, 4 in 1 Test Kit, All-Brush Vacuum Head, Pool Broom 45cm, CPR Resuscitation Chart and Telescopic Handle.



Vacuum Hose – Automatic

| | | |
|--------|--------------------|--|
| CHX709 | Aussie Gold Ozflex | 38mm x 9m, suits all automatic cleaners |
| CHX712 | Aussie Gold Ozflex | 38mm x 12m, suits all automatic cleaners |
| CHX715 | Aussie Gold Ozflex | 38mm x 15m, suits all automatic cleaners |

2 year warranty.

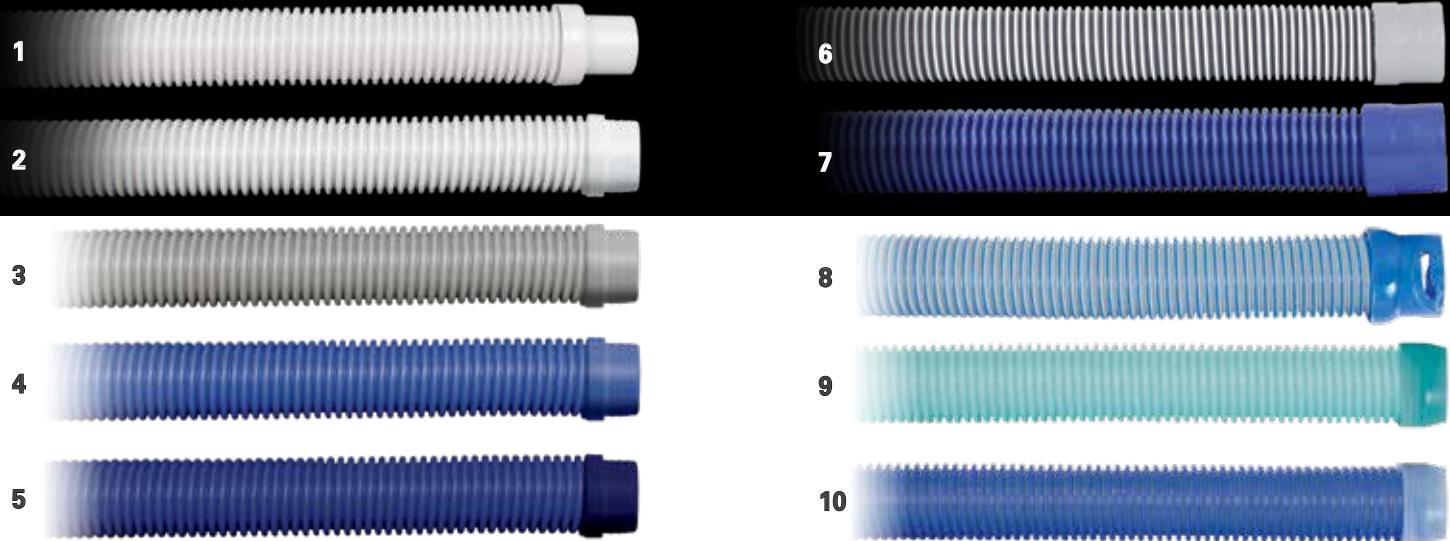

Vacuum Hose – Automatic

This high quality hose is now the most popular replacement hose. Autometre hose comes with a 2 year warranty.

| | | | |
|---|--------|--|------|
| 1 | CHQ081 | Aussie Gold Type A 1.0m White – suits Hayward Cleaners | 24pk |
| 2 | CHQ085 | Aussie Gold Type B 1m White – suits Zodiac & Questa | 24pk |
| 3 | CHQ087 | Aussie Gold Type B 1m Grey – suits Zodiac | 24pk |
| 4 | CHQ089 | Aussie Gold Type B 1m Pearl Blue – suits Zodiac/Avenger | 24pk |
| 5 | CHQ080 | Aussie Gold Type B 1m Twin Blue – suits Zodiac/Avenger | 30pk |

| | | | |
|----|------------|---------------------------------------|--------|
| 6 | AB-26015 | Zodiac Hose 1.0m Jumbo Grey Stripe | 30pk |
| 7 | AB-26035 | Zodiac Hose 1.0m Jumbo Light Blue | 30pk |
| 8 | AB-26060 | Zodiac Hose 1.0m Jumbo Global | 30pk |
| 9 | AC-OH59616 | Hammerhead Hose | Single |
| 10 | CHQ091 | Rebel Cleaner Hose | Single |
| | CHQ090 | Rebel Cleaner Hose | 12pk |



Vacuum Hose – Manual

Smoother interior to reduce internal friction resulting in superior vacuum performance. 2 year manufacturers warranty.

| | | |
|------------|----------|------------|
| H-PLS38/9 | Poolside | 38mm x 9m |
| H-PLS38/11 | Poolside | 38mm x 11m |
| H-PLS38/13 | Poolside | 38mm x 13m |
| H-PLS38/15 | Poolside | 38mm x 15m |
| H-PLS38/20 | Poolside | 38mm x 20m |

All Seasons Hose – Manual

Sturdy, UV-stabilised hose. An excellent value vacuum hose

| | | |
|--------|-----------------------|------------|
| CHV009 | All Seasons Pool Hose | 38mm x 9m |
| CHV011 | All Seasons Pool Hose | 38mm x 11m |
| CHV013 | All Seasons Pool Hose | 38mm x 13m |

Vacuum Hose – Manual

Our Aussie Gold Premier Vacuum Hose is manufactured from a high quality blend of plastics to withstand our harsh summer climate. 2 year manufacturers warranty.

| | | |
|--------|---------------------|------------|
| CHA209 | Aussie Gold Premier | 32mm x 9m |
| CHA211 | Aussie Gold Premier | 32mm x 11m |
| CHA809 | Aussie Gold Premier | 38mm x 9m |
| CHA811 | Aussie Gold Premier | 38mm x 11m |
| CHA813 | Aussie Gold Premier | 38mm x 13m |
| CHA815 | Aussie Gold Premier | 38mm x 15m |



Vacuum Hose – Manual

| | | | |
|---|--------|----------------------|------------|
| 1 | CHP425 | Hose Spiggotted | 38m x 20m |
| 2 | CHP438 | Hose Spiggotted Grey | 38mm x 50m |

| | | | |
|---|--------|-----------------|------------|
| 3 | CHP338 | Hose Spiral | 38mm x 50m |
| 4 | CHP420 | Hose Spiggotted | 32mm x 20m |

Layflat Hose

| | | | |
|---|-----------|---------------|------------|
| 1 | H-LF40/20 | Lay Flat Hose | 40mm x 20m |
| 2 | H-LF50/20 | Lay Flat Hose | 50mm x 20m |

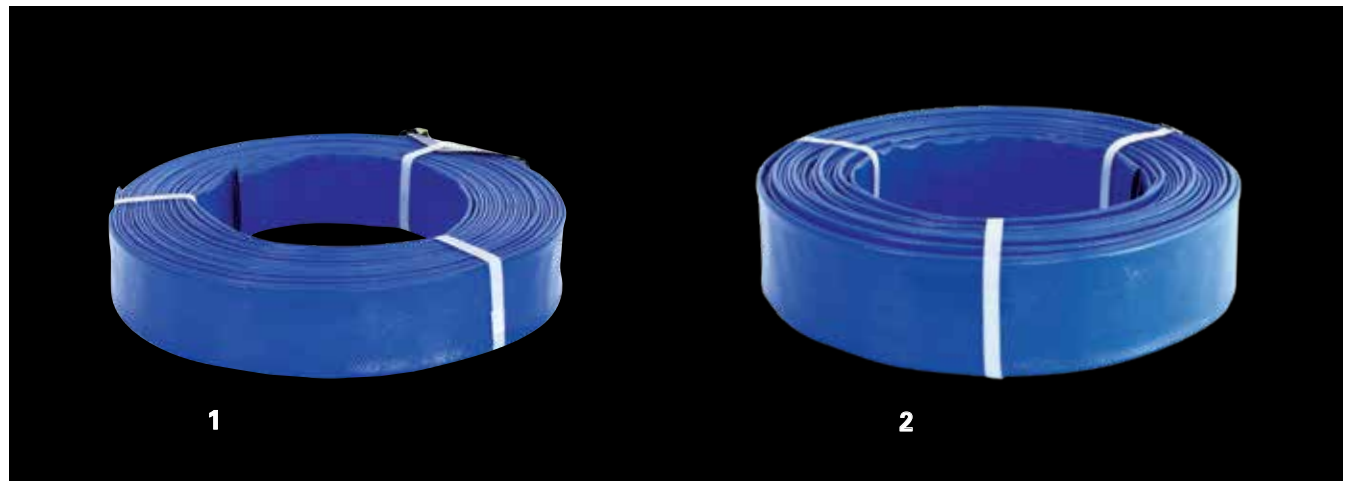



Residential Test Kits & Spares

Aussie Gold Test Kits provide pool owners with fast and accurate pool water chemistry analysis.

| | | |
|---|--------|-----------------------------|
| 1 | TKA401 | Test Kit 4 in 1 Aussie Gold |
| 2 | TKA201 | Test Kit 2 in 1 Aussie Gold |

| | | |
|---|--------|--|
| 3 | TPA682 | Aussie Gold Test Vial DPD Replacements |
| 4 | TPA684 | Aussie Gold Test Vial DPD Replacements |



Waterlink Test Kits and Spin Disc

| | | |
|---|-------------|--|
| 1 | TK-3577AU | Waterlink Spin Mobile |
| 2 | TK-XX01439 | Waterlink Spin |
| 3 | TK-1189-3 | Waterlink Spin Syringe - Pack of 3 |
| 4 | TK-1189-TIP | Waterlink Spin Syringe Tip - Pack of 3 |

| | | |
|---|-----------|--|
| 5 | TK-4328-H | Waterlink Spin Reagent Disc - Chlorine |
|---|-----------|--|

| | | |
|---|-----------|---|
| 6 | TK-4329-H | Waterlink Spin Reagent Disc - Phosphate |
|---|-----------|---|



Taylor Test Kits, Reagents & Spares

The Taylor professional laboratory and test kits offer the ultimate in water testing and also enhance your image as being a professional pool shop or service operator.

| | | |
|---|--------|-------------------------------|
| 1 | TKT830 | Test Kit Calcium K1770 Taylor |
| 2 | TKT818 | Test Kit Copper K1738 Taylor |
| 3 | TKT826 | Test Kit Iron K1716 Taylor |
| 4 | TKT442 | Complete Service Kit K2005C |



Aussie Gold Test Solutions

| | | | |
|---|--------|------------------------------|---------|
| 1 | TSS264 | Test Solution Cyanuric Acid | 5 litre |
| 2 | TSS826 | Calibration Solution 6000ppm | 250ml |



Taylor Reagents

A full range of Taylor Test Reagents is available. See the Price List for details.

| | | |
|----|--------|-----------------------------|
| 1 | TRT116 | R-0001 DPD NO 1 |
| 2 | TRT127 | R-0002 DPD NO 2 |
| 3 | TRT135 | R-0003 DPD NO 3 |
| 4 | TRT143 | R-0004 pH Indicator |
| 5 | TRT156 | R-0005 Acid Demand |
| 6 | TRT167 | R-0006 Base Demand |
| 7 | TRT173 | R-0007 Thiosulfate N10 |
| 8 | TRT186 | R-0008 Alkalinity Indicator |
| 9 | TRT193 | R-0009 Sulfuric Acid |
| 10 | TRT203 | R-0010 Calcium Buffer |
| 11 | TRT218 | R-0011L Calcium Indicator |
| 12 | TRT223 | R-0012 Hardness |
| 13 | TRT233 | R-0013 Canuric Acid |

| | | |
|----|--------|----------------------|
| 14 | TRT627 | R-0852 Iron NO 2 |
| 15 | TRT636 | R-00853 Acid Demand |
| 16 | TRT665 | R-0860 Copper NO 1 |
| 17 | TRT676 | R-0861 Copper NO 2 |
| 18 | TRT685 | R-0862 Base Demand |
| 19 | TRT823 | R-1003J pH Indicator |



Aussie Gold Reagents

A full range of Aussie Gold Test Reagents is available. See the Price List for details.

| | | | |
|---|--------|--|------|
| 1 | TSA102 | Test Solution 2 - pH | 30ml |
| 2 | TSA103 | Test Solution 3 - Acid Demand | 30ml |
| 3 | TSA104 | Test Solution 4 - Chlorine Neutraliser | 15ml |
| 4 | TSA105 | Test Solution 5 - Total Alkalinity | 15ml |
| 5 | TSA111 | Test Solution - Phenol Red | 15ml |



Aussie Gold Test Strips

A complete selection of Aussie Gold test tablets is available. See the Price List.

| | | | |
|---|--------|----------------------------|--------|
| 1 | TDQ012 | Test Strip 5 in 1 Quikchek | 12pk |
| 2 | TDQ050 | Test Strip 5 in 1 Quikchek | Single |

Aussie Gold Test Tablets

A complete selection of Aussie Gold test tablets is available. See the Price List for details.

| | | |
|--------|---------------|--------|
| TTT010 | Cyanuric Acid | 1000pk |
| TTT136 | DPD No. 1 | 1000pk |
| TTT347 | DPD No. 3 | 1000pk |
| TTT781 | Phenol Red | 1000pk |



Other Test Strips

Test for Total Hardness, Total Chlorine, Total Bromine, Free Chlorine, pH, Total Alkalinity and Cyanuric Acid.

| | | | |
|---|-----------|------------------------------|-------|
| 1 | RE-TSAC4 | AquaCheck Free Chlorine | 50pk |
| 2 | RE-TSACB | AquaCheck Total Bromine | 50pk |
| 3 | RE-TSACST | AquaCheck Salt Test Strips | 10pk |
| 4 | TAQ601 | AquaCheck 7 | 100pk |
| 5 | RE-TS61-P | Palintest 6 in 1 Test Strips | 50pk |
| 6 | RE-TS31-C | Palintest 3 in 1 Test Strips | 50pk |



Lovibond Photometer Tablets

A complete selection of Lovibond photometer tablets is available. See the Price List for details.

| | | |
|--------|------------------------------|-----------|
| TTP010 | Alkalinity HR 5-500ppm | 250pk |
| TTP120 | Alkalinity LR 5-200ppm | 250pk |
| TTP020 | Calcium - H Combined Pack | 2 x 250pk |
| TTP030 | Copper No. 1 | 250pk |
| TTP040 | Coppercol - Combined Pack | 2 x 250pk |
| TTP050 | Cyanuric Acid | 250pk |
| TTP060 | DPD No. 1 | 250pk |
| TTP070 | DPD No. 3 | 250pk |
| TTP080 | DPD No. 4 | 250pk |
| TTP100 | Phenol Red | 250pk |
| TTP110 | Phosphate - LR Combined Pack | 2 x 250pk |
| TTP130 | High Calcium | 100pk |



Palintest Photometer Tablets

A complete selection of compatible with Palintest Photometers. See the Price List for details.

| | | | |
|---|-------------|---|-----------|
| 1 | RE-AP177 | Phosphate LR | 200pk |
| 2 | RE-AP252 | Calcicol 1 + 2 | 2 x 250pk |
| 3 | RE-AP017 | DPD Oxystop | 250pk |
| 4 | TKP-PT595/5 | Round Test Tube Glass | 5pk |
| 5 | TK-PT502 | Palintest Crush Sticks | Single |
| 6 | TKP-709 | Pooltest 9 Bluetooth Kit (Other models available) | |
| | TKP-367 | Pooltest 3 Photometer | |
| | TKP-006DH | Pooltester 6 Photometer | |
| | TKP-709 | Pooltester 9 Photometer | |
| | RE-AP011 | DPD No 1 | 250pk |
| | RE-AP013 | DPD XF | 250pk |
| | RE-AP021 | DPD No 2 | 250pk |
| | RE-AP031 | DPD No 3 | 250pk |
| | RE-AP033 | DPD XT | 250pk |

| | | | |
|--|----------|----------------------|-----------|
| | RE-AP041 | DPD No 4 | 250pk |
| | RE-AP056 | Ozone | 250pk |
| | RE-AP060 | Bromine | 250pk |
| | RE-AP087 | Cyanuric Acid | 250pk |
| | RE-AP105 | Hydrogen Peroxide HR | 250pk |
| | RE-AP130 | pH Phenol Red | 250pk |
| | RE-AP152 | Ammonia | 250pk |
| | RE-AP155 | Iron LR | 250pk |
| | RE-AP173 | Manganese | 250pk |
| | RE-AP186 | Coppercol 1 + 2 | 2 x 250pk |
| | RE-AP187 | Coppercol (free) | 250pk |
| | RE-AP188 | Alkaphot | 250pk |
| | RE-AP254 | Hardicol | 250pk |
| | RE-AP268 | Chloridol Salt | 250pk |



Taylor Spares

| | | |
|---|--------|---------------------------|
| 1 | TPA444 | Test Cell – 11.5ml 4024 |
| 2 | TPA416 | Test Pipette – 1.0ml 4030 |
| 3 | TPA412 | Test Pipette – 0.5ml 4028 |
| 4 | TPA213 | Test Tube Ca 9192 |

| | | |
|---|--------|--------------------------------|
| 5 | TPA300 | Test Plunger Cyanuric Acid |
| 6 | TPA216 | Test Dispensing Bottle Ca 9194 |
| 7 | TPA218 | Test Dispensing Bottle Ca 9191 |

| | | |
|---|--------|------------------------------------|
| 8 | TPC090 | Test Cylinder Cell 10ml Single |
| 9 | TPA689 | Test Cell Block Chlorine / pH 9056 |



LaMotte Test Reagents

| | | |
|---|-----------|-----------------------------------|
| 1 | TPA701 | Pro 7 - Test Tubes (5ml) |
| 2 | RE-L7042G | Pro 7 (30ml) Calcium Hardness No1 |
| 3 | RE-L7041G | Pro 7 (30ml) Calcium Hardness No2 |
| 4 | RE-LP6740 | Pro 7 (30ml) DPD 1A |
| 5 | RE-LP6741 | Pro 7 (30ml) DPD 1B |
| 6 | RE-LP6743 | Pro 7 (30ml) DPD 3 |
| 7 | RE-L7037 | Pro 7 (30ml) Phenol Red |
| 8 | RE-L7038 | Pro 7 (30ml) Total Alkalinity |
| 9 | RE-L6966A | Pro 7 Cyanuric Test Tablets |



Photometer & Test Meters

| | | |
|---|------------|-------------------------------|
| 1 | TKL700 | Photometer Colour Q Pro 7 |
| 2 | TMB357 | Test Meter Salt Indicator T11 |
| 3 | TK-SLDT100 | Salinity TDS Meter |



Skimmer Socks

| | | | |
|---|--------|--|--|
| 1 | MFS305 | Regular Aussie Gold 5 x 20 per Display | Aussie Gold Skimmer Socks, presented in an eye-catching counter display, generate great repetitive sales to all pool owners. Skimmer socks keep pool free of leaves, fine debris and reduce filter cleaning frequency. |
| 2 | MFS905 | Mega Aussie Gold 5 x 20 per Display | Jumbo Skimmer Socks are 40% larger than our regular Skimmer Sock and have been designed to easily fit all large skimmer baskets |



Floating Thermometers

| | | |
|---|--------|--|
| 1 | MTH612 | Floating Deluxe Aussie Gold 12pk Display |
| 2 | MTH632 | Jumbo Convertible Aussie Gold Blister Pack |
| 3 | MTH618 | Floating Deluxe Aussie Gold Blister Pack |

| | | |
|---|--------|------------------------------------|
| 4 | MTH700 | Chrome Deluxe Life Blister Pack |
| 5 | MTH760 | Crocodile Aussie Gold Blister Pack |
| 6 | MTH770 | Duck Aussie Gold Blister Pack |

| | | |
|---|--------|--|
| 7 | MTH780 | Frog Aussie Gold Blister Pack |
| 8 | MTH810 | Floating Deluxe True Blue Blister Pack |



Floating Dispensers

| | | |
|--|--------|---------------------------------------|
| 1 | MDI642 | Aussie Gold Floating Tablet Dispenser |
| 2 | MDI657 | Spa Floating Dispenser |
| 3 | MDI802 | Bromine Life Floating Dispenser |
| Unique Bromine/Chlorine dispenser intended for use in spas. Notable features include: locking ring, anchor cord, and removable bottom cap for easy re-filling. | | |



Resuscitation Charts

| | | |
|--|--------|---|
| 1 | MPS527 | Aussie Gold Colourbond CPR Sign DRSABCD |
| 2 | MPS522 | Aussie Gold PVC CPR Sign DRSABCD |
| Constructed from high grade, high impact PVC | | |
| 3 | MPS515 | Life CPR Sign DRSABCD Colourbond |

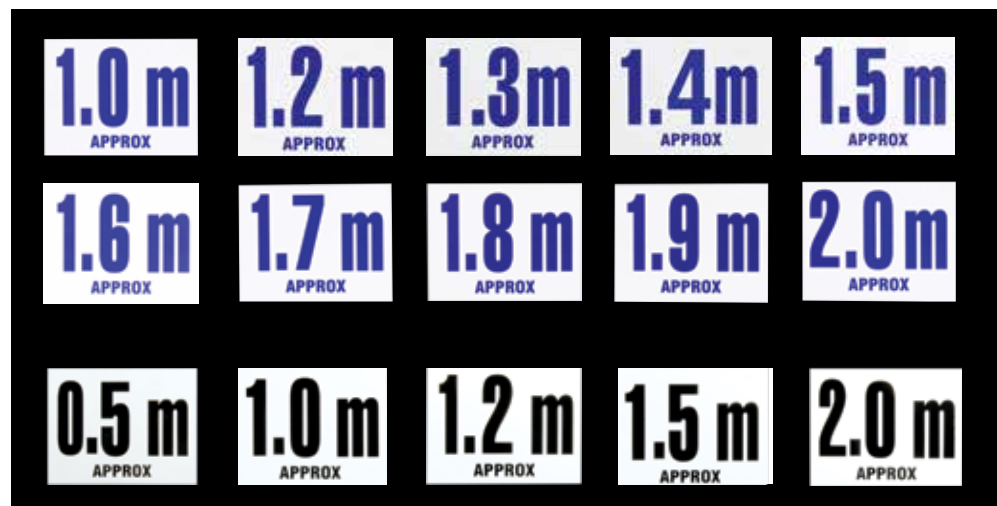

Depth Marker Signs

Extensive line of depth and safety markers designed to meet code requirements for all applications.

| Blue on White | |
|---------------|---------------------|
| PX-DM1.0 | Depth Marker – 1.0m |
| PX-DM1.1 | Depth Marker – 1.1m |
| PX-DM1.2 | Depth Marker – 1.2m |
| PX-DM1.3 | Depth Marker – 1.3m |
| PX-DM1.4 | Depth Marker – 1.4m |
| PX-DM1.5 | Depth Marker – 1.5m |
| PX-DM1.6 | Depth Marker – 1.6m |
| PX-DM1.7 | Depth Marker – 1.7m |

| PX-DM1.8 | Depth Marker – 1.8m |
|----------------|---------------------|
| PX-DM1.9 | Depth Marker – 1.9m |
| PX-DM2.0 | Depth Marker – 2.0m |
| Black on White | |
| MPS005 | Depth Marker – 0.5m |
| MPS010 | Depth Marker – 1.0m |
| MPS012 | Depth Marker – 1.2m |
| MPS015 | Depth Marker – 1.5m |
| MPS020 | Depth Marker – 2.0m |



SandPro Pump & Filter Systems

Complete Replacement Sand Filter Unit. Powerful, ultra quiet self-priming pump generates maximum water flow that will quietly clean and circulate the pool water. Easy DIY installation and ideal for INTEX® & Bestway Pool packages and steel walled above ground pools.

Features

- 3/4 HP or 1/2 HP pump
- High efficiency impeller for maximum water flow and minimal noise
- Easy to operate 4 position rotary valve (filter, backwash, rinse & winterize)
- Large capacity, easy to clean pump basket with see-through lid
- Hose fitting adaptors work with 32mm, 38mm & Intex 40mm hoses
- 12 month limited warranty

| | | |
|---|------------|--------------------|
| 1 | F-PSMPC340 | SandPro 75D 3/4 HP |
| 2 | F-PSMPC250 | SandPro 50D 1/2 HP |



General Maintenance

| | | |
|---|--------|-----------------------------|
| 1 | MCL818 | Time Switch – 24hr, 818 Hpm |
| 2 | MPU971 | The Ultimate Pool Guide |
| 3 | MSB468 | Scumbug Degreaser |
| <p>Great for eliminating the “slick” caused by sunscreen lotion. Also ideal for preventing unsightly scum lines around pools and spas. Scum bug absorbs up to 40 times its own weight. Reusable – to clean, either rinse out and squeeze or simply stand on it and return to pool or spa.</p> | | |

General Maintenance continued overleaf ▷



General Maintenance

| | | |
|---|--------|------------------------------|
| 1 | MCJ120 | Clean-a-Cell Jug Aussie Gold |
| Clean-a-Cell with unique cleaning tool – 2 litre capacity. Takes the hard work out of cleaning Salt Chlorinator Cells. This specifically designed jug now makes cell cleaning a breeze. A unique plastic cleaning/scraping tool provides easy access to all “hard to reach” sections of the chlorinator cell. | | |

| | | |
|---|--------|---------------------------------------|
| 2 | MMJ001 | Measuring Jug 1 Litre Aussie Gold |
| 3 | MCJ005 | Life Measuring Jug - 500ml |
| 4 | ZAS008 | Pool Fast Water Sample Bottle - 500ml |
| 5 | FPC020 | Pool Liner Clips – 20pk |

| | | |
|---|--------|--|
| 6 | WP-TAP | Aeroflow Tap – suits most liquid chlorine containers |
|---|--------|--|

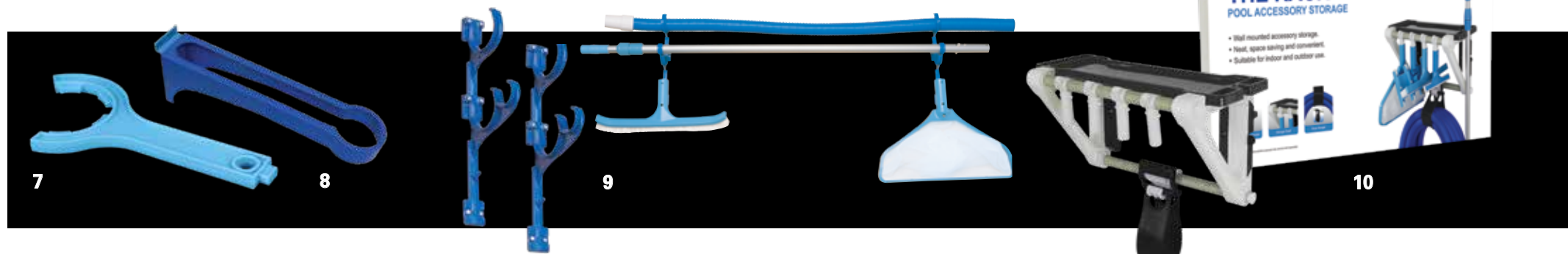

| | | |
|---|--------|-------------------------------------|
| 7 | MVT807 | Cap Spanner Half Circle Aussie Gold |
| Plus bung remover. For easy removal of tightly sealed chlorine drums and chemical containers. | | |
| 8 | ZAS700 | Hose Holder – Holds 5 lengths |
| Attaches to most wall types including slat wall. | | |

| | | |
|--|--------|---------------------------|
| 9 | MPH110 | Hang ‘n’ Hold Aussie Gold |
| Hang ‘n’ Hold Pool Hose and Pole Holder set of 2. Keep the pool area tidy. Quick and easy storage for your telescopic pole, pool hose and cleaning equipment. Screws included. | | |

| | | |
|--|--------|-----------------------------------|
| 10 | MSS100 | The Rack - Pool Accessory Storage |
| Neat, space saving and convenient wall mounted accessory storage system. | | |

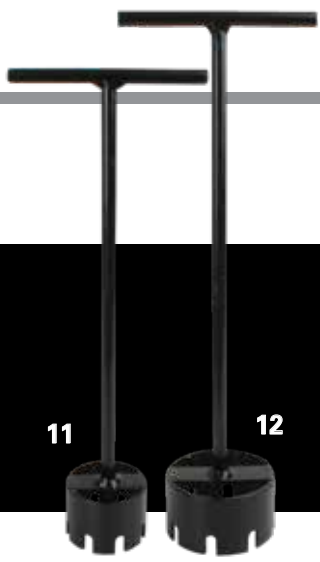

| | | |
|----|-------|---|
| 11 | T-HS4 | Spanner – 40mm, suits hydrostatic valve |
| 12 | T-HS5 | Spanner – 50mm, suits hydrostatic valve |

| | | |
|----|--------|--------------------------------------|
| 13 | MRT650 | Thread Seal Tape 10pk |
| 14 | MGT350 | Gripper Tool – pump lid removal tool |

| | | |
|---|----------|----------------|
| 15 | C-V50204 | Tool Caddy Box |
| Multiple compartments to easily carry chemicals, tools, test kit, cleaning equipment and anything else need possible. | | |

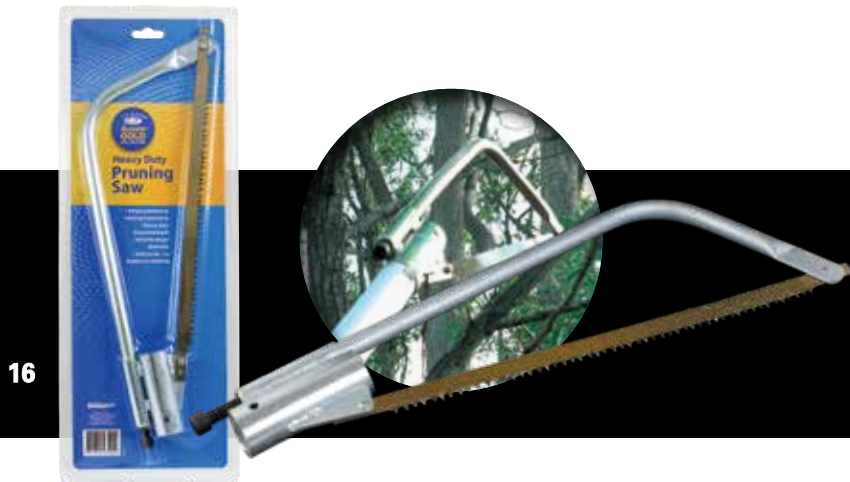

| | | |
|---|--------|------------------------|
| 16 | MPP200 | Pruning Saw Heavy Duty |
| This heavy duty pruning saw is constructed from anodized steel and comes complete with razor sharp saw blade for larger and harder to reach branches. | | |

| | | |
|---|--------|------------------------------|
| 17 | MPP005 | Pool Pole Pruner Aussie Gold |
| Ideal for unsightly and annoying palm fronds and other vegetation. Simply fits onto any telescopic pole. Reach and trim high branches safely. Can also be used as a hand saw. | | |

| | | |
|--|--------|-----------------|
| 18 | MVS358 | PVC Pipe Cutter |
| Essential tool for every service person and handyman. Perfect alternative to the hacksaw in all tight spots, including trenches, walls and fences. | | |

26 General Products | Miscellaneous



Miscellaneous

| | | |
|---|--------|----------------------|
| 1 | MHN100 | High Pressure Nozzle |
| 2 | MWE250 | Party Pool |

| | | |
|---|-------------|-----------------|
| 3 | W-25604-300 | Water Leveller |
| 4 | BR-PS | Poolstone Block |

| | | |
|---|--------|--------------------|
| 5 | MWF001 | Waterfall Fountain |
|---|--------|--------------------|



| | | |
|--|---------|---|
| 6 | PL-VPSS | Venturi Pump Stainless Steel Heavy Duty |
| <p>Superior action provides fast and efficient removal of sand from filters requiring repair or removal. Connects to a standard garden hose and has no costly replacement parts and is constructed from heavy duty cast 304 stainless steel.</p> | | |

| | | |
|--|--------|------------|
| 7 | PL-ZSS | Supa Sucka |
| 8 | MGJ200 | Genie Jet |
| <p>The ideal service person's tool that attaches to a garden hose, inserted into a blocked pipe or skimmer and expands to clear blockages (suits 40mm)</p> | | |

| | | |
|---|--------|---------------------------------|
| 9 | MLD250 | Dye Refill 236ml (40 refills) |
| 10 | MLD456 | Leak Detector Syringe & Dye Set |
| <p>This special heavy dye "hangs" in the water and is easy to detect visually when it is sucked into a suspected plumbing or shell leak location.</p> | | |



Repair Products

Complete range of leak detection and repair solutions, both above or below the water line.

| | | |
|---|---------|--|
| 1 | MRE108 | Emerkit Putty – Service Pack, Set of 8 |
| 2 | PX-SKI | Selly's Marine Selleys Aqua Knead It |
| 3 | WP-FL32 | Fix-a-Leak |
| 4 | AZD001 | Seal-A-Leak 1kg |
| 5 | MRE701 | Emerkit Pool Putty – Retail Pack |

| | | |
|----|------------|--|
| 6 | MRP001 | Aqua Fix-It |
| 7 | MRL506 | Pool Liner Repair Kit – 60ml tube - Display of 6 |
| 8 | WP-JB50172 | JB-Weld Marine Weld 25ml |
| 9 | WP-JB31310 | JB Weld Silicone - Clear 85g |
| 10 | PX-VPL | Patch Kit |



Test Plugs & Expansion Plugs

| | | |
|---|--------|------------------------------|
| 1 | MXP225 | Expansion Plug Tapered 25mm |
| 2 | MXP240 | Expansion Plug Tapered 40mm |
| 3 | MXP250 | Expansion Plug Tapered 50mm |
| 4 | MXP040 | Expansion Plug Straight 40mm |
| 5 | MXP050 | Expansion Plug Straight 50mm |

| | | |
|----|----------|------------------------------|
| 6 | PL-EX25S | Ext Plug Parallel Sided 25mm |
| 7 | PL-EX32S | Ext Plug Parallel Sided 32mm |
| 8 | PL-EX40S | Ext Plug Parallel Sided 40mm |
| 9 | PL-EX50S | Ext Plug Parallel Sided 50mm |
| 10 | MXA120N | Test Plug Nylon Closed 24mm |

| | | |
|----|---------|-----------------------------|
| 11 | MXA125N | Test Plug Nylon Closed 27mm |
| 12 | MXA140N | Test Plug Nylon Closed 35mm |
| 13 | MXA150N | Test Plug Nylon Closed 41mm |
| 14 | MXA155N | Test Plug Nylon Closed 48mm |



Magna Latch

| | | |
|---|--------|-------------------------------------|
| 1 | MHC056 | Safety Cap Standard Series 2 |
| Hinge safety cap prevents toddlers from using the hinge as a toehold. | | |
| 2 | MHS053 | Tru Close Hinge Set Series 3 |
| 3 | MHH054 | Tru Close Heavy Duty Hinge Set MKII |
| Self-closing hinge for heavier or high-traffic gates around commercial areas and homes. | | |
| 4 | MHH060 | Round Post Hinge |
| Designed to fit a wide range of common round-posted gates and fences. Each pair of hinges is packaged as a kit that includes shims/adaptors to fit each post. | | |
| 5 | MGS053 | Tru Close Gate Stop |
| 6 | MHC076 | Safety Cap Heavy Duty Series 2 |
| 7 | MMA050 | Round Post Adaptor Kit |

| | | |
|---|--------|-------------------|
| 8 | MMG001 | Safety Gate Kit |
| Includes Top Pull, Magna Latch, and 2 x Standard Hinges | | |
| 9 | MML053 | Top Pull Series 3 |
| With its Lost-Motion Technology, the innovative magnetic action engages every time and stays shut, no matter how much it's pulled or shaken, offering greater safety and security. For convenience, the key lock can now also be rekeyed to match to other locks around the property. A visible Lock Indicator shows you at a glance whether it's locked or unlocked. | | |
| 10 | MPL502 | Vertical Pull |
| A shorter version of the Top Pull Model latch. Vertical Pull shares the same features and is ideal for safety gates around swimming pools. | | |
| 11 | MSP052 | Side Pull |
| An ideal general purpose latch. | | |

| | | |
|--|--------|---|
| 12 | MSP025 | Side Pull with Lock |
| <ul style="list-style-type: none"> • Key lockable! • Patented 'Lost Motion Technology' (same safety factor as Top Pull model) • Ideal for glass pool gates • Adjustable, vertically & horizontally • No rust or binding | | |
| 13 | MHC053 | Safety Cap Standard Series 3 |
| 14 | MML055 | MagnaLatch Alert Safety Gate Latch with Alarm |
| Alert - Features built-in sensors to give a visual and audible alarm alert when the gate is opened and closed, or locked or unlocked. The electronic alarm is powered by an integrated, replaceable battery. | | |
| 15 | MHC057 | Safety Cap Heavy Duty Series 3 |



Aussie Gold Restore Filter Cleaner

Aussie Gold Restore Filter Cleaner is a specialty cleaner that makes it easy to maintain your crystal clear pool water and increases the life of your pool equipment.

| | | |
|--------|------------------------|---------------------|
| ARC012 | Restore Filter Cleaner | 250g x 12 (Display) |
|--------|------------------------|---------------------|



Aussie Gold Shimmer Clarifying Tablets

Shimmer Clarifying Tablets are a NEW generation of tablet to keep your pool water healthy and shimmering clear.

| | | |
|--------|--------------|--------------------|
| ACP060 | Shimmer Tabs | 60g x 54 (Display) |
|--------|--------------|--------------------|



Aussie Gold Crystal Cubes

These clarifying cubes provide excellent water clarity and a "fast no-mess" alternative to conventional chemical treatments. Just drop one into the pump or skimmer basket and watch the sparkle return to the water. The perfect additive for sand filters.

| | | |
|----------|------------------------|-------------|
| ACP340 | Crystal Cube Twin Pack | 170g (Box) |
| ACP170-B | Crystal Cube Single | 170g (Bulk) |



Lube-it

Superior and long lasting lubricant for pool and spa equipment. For use on filter gaskets, pumps, motors, valves, bearings, seating and rejuvenating O-Rings

| | | |
|---------|--------------|--------------------|
| ALH030 | Lube-It | 30g x 20 (Display) |
| ALH750 | Lube-It | 75g x 10 (Display) |
| ALH005 | Lube-It | 500g (Jar) |
| O-SL250 | Molytec Lube | 250g (Spray) |



Media

| | | | |
|---|------------|-----------------|------|
| 1 | F-Z15 | Zelbrite Media | 15kg |
| 2 | F-SAN1(20) | Filter Sand 1mm | 20kg |

| | | | |
|---|---------|----------------------|------|
| 3 | F-NFC15 | Glass Media (Coarse) | 15kg |
| 4 | F-NFF15 | Glass Media (Fine) | 15kg |



Erase It

Triple action all purpose stain remover. Erase It offers an alternative cleaning solution from other harsh chemicals, is easy to use, safe and produces instant results. Contains no chemicals and will not scratch or gouge the recommended surfaces.

| | |
|--------|-----------------------------|
| MZE100 | Erase It – Concrete/Plaster |
| MZE200 | Erase It – Calcium |
| MZE300 | Erase It – Vinyl/Spa |
| MZE400 | Erase It – Tile/Grout |



Solutions

| | | | |
|---|---------|---------------|-------------|
| 1 | WP-KDS1 | Duck Solution | 1L (Bottle) |
| 2 | AFE600 | Pool Refresh | 1L (Bottle) |



PVC Pipe & Fittings

| | | |
|---|------------|-----------------------------|
| 1 | PL-BU40 | Barrel Union 40mm |
| 2 | PL-BU50 | Barrel Union 50mm |
| 3 | PU-H950919 | Union Lock Nut Hurlcon 50mm |
| 4 | PU-H950920 | Union Tail Hurlcon 50mm |

| | | |
|---|------------|--------------------------------------|
| 5 | FBU540 | Union Tail Hurlcon 40mm/50mm |
| 6 | FBU642 | Half Union Waterco 40mm |
| 7 | PL-W634024 | Half Union Waterco 50mm |
| 8 | PL-BUT40 | Union Assembly Threaded Hurlcon 40mm |
| 9 | FBU650 | Union Assembly Threaded Hurlcon 50mm |

| | | |
|----|------------|------------------------------|
| 10 | PU-H76015 | Hurlcon Union Tail 40mm |
| 11 | PU-PR1331 | Poolrite Union Take Off 50mm |
| 12 | PU-PR1305 | Poolrite Union 40mm (Black) |
| 13 | PL-W634024 | Half Union Waterco 50mm |
| 14 | PU-H950922 | Hurlcon Threaded Tail 40mm |



| | | |
|---|---------|--------------------------------|
| 1 | PL-CR40 | Repair Coupling Quick-Fix 40mm |
| 2 | PL-CR50 | Repair Coupling Quick-Fix 50mm |
| 3 | PL-FA40 | Faucet Adaptor Female 40mm |
| 4 | PL-FA50 | Faucet Adaptor Female 50mm |

| | | |
|---|---------|---------------------------|
| 5 | FFS050 | Faucet Socket Female 50mm |
| 6 | PL-FS40 | Faucet Socket Female 40mm |
| 7 | FPC140 | Cap Pipe 40mm 10pk |
| 8 | FPC150 | Cap Pipe 50mm 5pk |

| | | |
|----|---------|-------------------------------|
| 9 | PL-CI40 | Internal Repair Coupling 40mm |
| 10 | PL-CI50 | Internal Repair Coupling 50mm |

PVC Pipe & Fittings

| | | |
|----|-------------|-----------------------------------|
| 1 | PL-C40 | Coupling 40mm 10pk |
| 2 | PL-C50 | Coupling 50mm 5pk |
| 3 | PL-45E40 | Elbow 45 Degree 40mm 10pk |
| 4 | PL-45E50 | Elbow 45 Degree 50mm 5pk |
| 5 | PL-90E40 | Elbow 90 Degree 40mm 10pk |
| 6 | PL-9E50 | Elbow 90 Degree 50mm 5pk |
| 7 | PL-T40 | Tee 40mm 10pk |
| 8 | PL-T50 | Tee 50mm 5pk |
| 9 | PL-B40/50 | Reducing Bush 50 x 40mm 5pk |
| 10 | PL-CRD50/40 | Reducing Coupling 50 x 40mm 5pk |
| 11 | PL-MA40 | Valve Adaptor Male 40mm 10pk |
| 12 | PL-MA50 | Valve Adaptor Male 50mm 5pk |
| 13 | FVS050 | Valve Socket Male 50mm 5pk |
| 14 | FVS040 | Valve Socket Male 40mm 10pk |
| 15 | SL-B9E40 | Black PVC Elbow 90 Degree/40mm |
| 16 | SL-B45E40 | Black PVC Elbow 45 Degree/40mm |
| 17 | PIP340 | PVC Pipe CL9 40mm x 3m 5pk |
| 18 | PIP350 | PVC Pipe CL9 50mm x 3m 5pk |
| 19 | PX-CPC | PVC Priming Fluid Clear 500ml |
| 20 | PX-SCP500C | PVC Solvent Cement Clear 500ml |
| 21 | PX-SCP250 | Solvent Cement Green 250ml Type P |
| 22 | PL-P12/25 | Class 12 Pipe 25mm x 6m |
| 23 | PL-P12/32 | Class 12 Pipe 32mm x 6m |



Eyeballs

| | | |
|----|-------------|---|
| 1 | FEY010 | Uni-Return Fitting White |
| 2 | FEY015 | Uni-Return Fitting Grey |
| 3 | FEY020 | Uni-Return Fitting Taupe |
| 4 | FEY030 | Uni-Return Fitting Black |
| 5 | FEY035 | Uni-Return Fitting Light Blue |
| 6 | FEY040 | Uni-Return Fitting Dark Blue |
| 7 | FEY045 | Uni-Return Fitting Light Grey |
| 8 | FEY450 | Threaded – Fibreglass/Vinyl |
| 9 | PF-710W | Spa Electrics SE701 Self Aligning White |
| 10 | PF-E40-W | Multi-directional Waterco 40mm White |
| 11 | PF-E50-W | Slip Fit Waterco 50mm White |
| 12 | SP-804 | Spa Electrics Jet 40mm - Concrete |
| 13 | PF-701C | Pushin Eyeball Return 40mm Clear |
| 14 | PF-O5115000 | Fibreglass Eyeball 40mm White |
| 15 | PF-E40W-M | Eyeball Magnor 32/40 slip White |
| 16 | PF-24 | Thread Eyeball Return 40mm White |
| 17 | SP-523 | Paramount Suction 40mm/sl Nut |
| 18 | PF-801W | Thread Eyeball Return 40mm |
| 19 | SP-709W | Bubbler Return Push-in 40mm White |
| 20 | PF-PFFK | Poolfab Eyeball Facia Kit |
| 21 | PF-PR2716 | Eyeball Vinyl 0-6mm White |



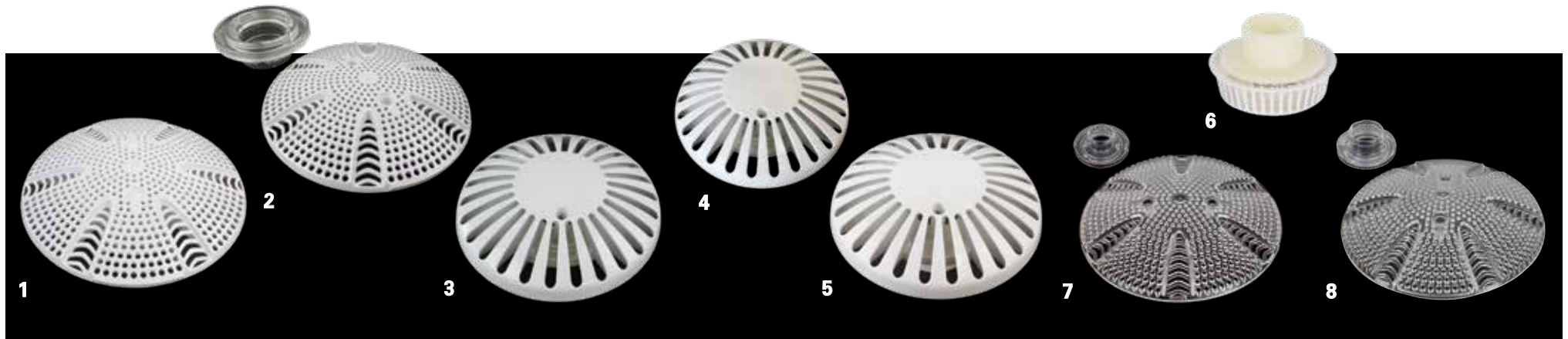

Safety Suctions

| | | |
|---|--------|---|
| 1 | SP-11W | Safety Suction Spa Electrics SE-11 40mm |
| 2 | SP-10W | Safety Suction Spa Electrics SE-10 50mm |

| | | |
|---|------------|------------------------------------|
| 3 | SP-W453496 | Safety Suction Waterco Slip 40mm |
| 4 | SP-W453498 | Safety Suction Waterco Thread 40mm |
| 5 | SP-W453497 | Safety Suction Waterco Slip 50mm |

| | | |
|---|--------|------------------------------------|
| 6 | SP-480 | Paramount Suction 40mm White |
| 7 | SP-10C | Safety Suction 40mm Slip Fit Clear |
| 8 | FSS240 | Safety Suction 50mm Push-in Clear |



Air Injections

| | | |
|---|--------|-------------------------------------|
| 1 | SP-242 | P/Mount Air Injector 25mm White |
| 2 | SP-243 | Paramount Air Injector 25mm (Beige) |

| | | |
|---|--------|----------------------------------|
| 3 | SP-170 | Paramount Air Control 25mm White |
| 4 | SP-202 | Paramount Low Air Button White |

| | | |
|---|--------|---------------------------------|
| 5 | SP-102 | Paramount Air Control STD White |
|---|--------|---------------------------------|

Aussie Gold, Aquamaid & Poolstore Valves

| | | |
|---|----------|---|
| 1 | FRV040 | Aussie Gold Valve Non Return 40mm |
| 2 | FRV050 | Aussie Gold Valve Non Return 50mm |
| 3 | PL-SWVC4 | Aquamaid Valve Swing Check 40/50mm |
| 4 | FVA142 | Aussie Gold Valve 2 Way 40mm |
| 5 | FVA143 | Aussie Gold Valve 3 Way 40mm |
| 6 | FVA152 | Aussie Gold Valve 2 Way 50mm |
| 7 | FVA153 | Aussie Gold Valve 3 Way 50mm |
| 8 | PL-SPC40 | Poolstore Spring Valve 40mm (Clear Lid) |
| 9 | PL-SPC50 | Poolstore Spring Valve 50mm (Clear Lid) |



Jandy Valves

| | | |
|---|-----------|------------------------|
| 1 | PL-JV2WV4 | Jandy 2 Way Valve 40mm |
| 2 | PL-JV2WV5 | Jandy 2 Way Valve 50mm |
| 3 | PL-JV3WV4 | Jandy 3 Way Valve 40mm |
| 4 | PL-JV3WV5 | Jandy 3 Way Valve 50mm |
| 5 | PL-JCV4 | Jandy Check Valve 40mm |
| 6 | PL-JCV5 | Jandy Check Valve 50mm |

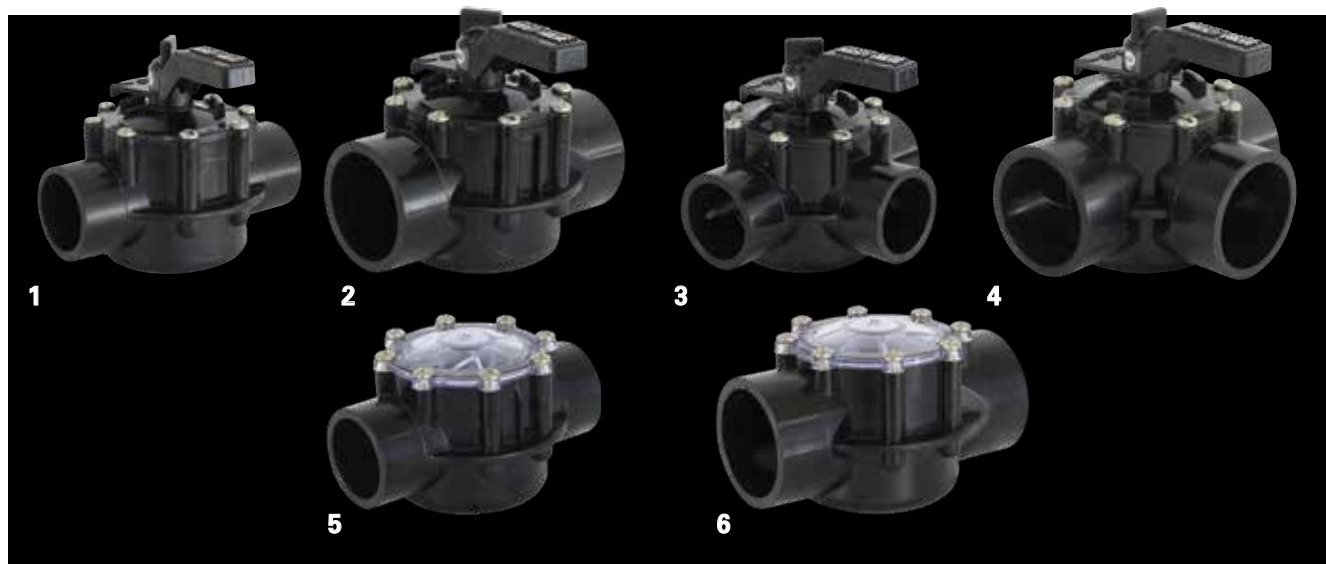

Spa-Quip & Hydrostatic Valves

| | | |
|---|-----------|------------------------------|
| 1 | PL-2TV4 | Valve 2 Way Spa Quip 40mm |
| 2 | PL-2TV5 | Valve 2 Way Spa Quip 50mm |
| 3 | PL-3TV4 | Valve 3 Way Spa Quip 40mm |
| 4 | PL-3TV5 | Valve 3 Way Spa Quip 50mm |
| 5 | PL-SP4080 | Valve Spring Check 40/50mm |
| 6 | FVA540 | Valve Gate (Push/Pull) 40mm |
| 7 | FVA550 | Valve Gate (Push/Pull) 50mm |
| 8 | PL-HSV4 | Valve Hydrostatic MD400 40mm |
| 9 | PL-HSV5 | Valve Hydrostatic MD800 50mm |



Pentair Valves

| | | |
|---|-------------|---------------------------|
| 1 | PL-PW263038 | 2-Way Diverter Valve 40mm |
| 2 | PL-PW263029 | 2-Way Diverter Valve 50mm |
| 3 | PL-PW263037 | 3-Way Diverter Valve 40mm |
| 4 | PL-PW263028 | 3-Way Diverter Valve 50mm |
| 5 | PL-O063042 | Spring Check Valve 50mm |



Ladder Parts

| | | |
|---|--------|----------------------------------|
| 1 | L-Lox | Loxin |
| 2 | L-Bol | Bolts 316 |
| 3 | L-SC | Pooldeck Suction/Rubber Buffer |
| 4 | L-LT | Pooldeck Ladder Tread |
| 5 | L-CROD | Ladder Tread Rod Washers and Nut |

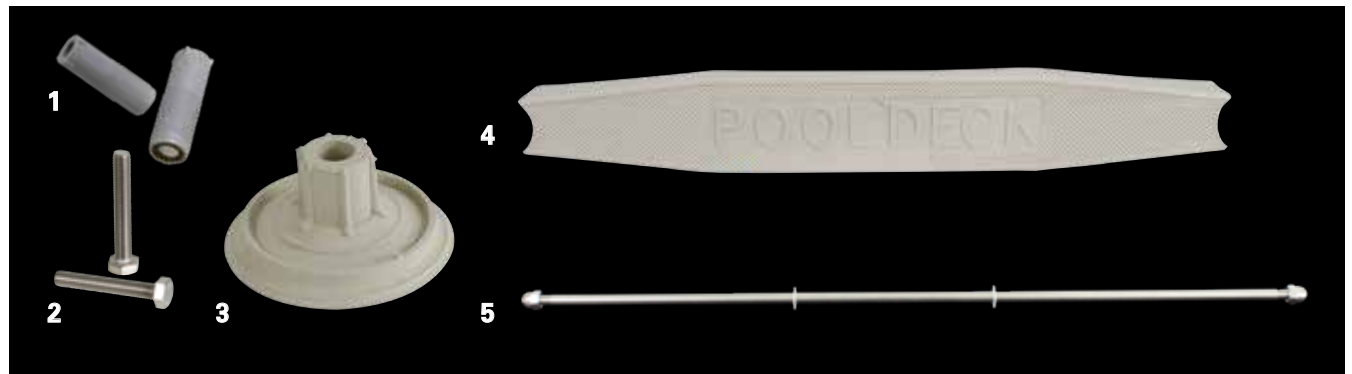

Avenger & Baracuda Parts

| | | |
|----|--------|-----------------------------|
| 1 | CPB007 | Pool Cleaner Skirt – Deluxe |
| 2 | CPB024 | Diaphragm Standard |
| 3 | CPB029 | Diaphragm Cassette |
| 4 | CPB036 | Hose Weight Semi-Circular |
| 5 | CPB054 | Leader Hose Adaptor |
| 6 | CPB014 | Blue Foot – Deluxe |
| 7 | CPB090 | Hand Lock Nut |
| 8 | CPB076 | Deflector Wheel – Large |
| 9 | CAP001 | Auto Pilot Assembly |
| 10 | CPB072 | Deflector Wheel – Standard |
| 11 | CPB086 | Inner Extension Pipe |
| 12 | CPB082 | Outer Extension Pipe |

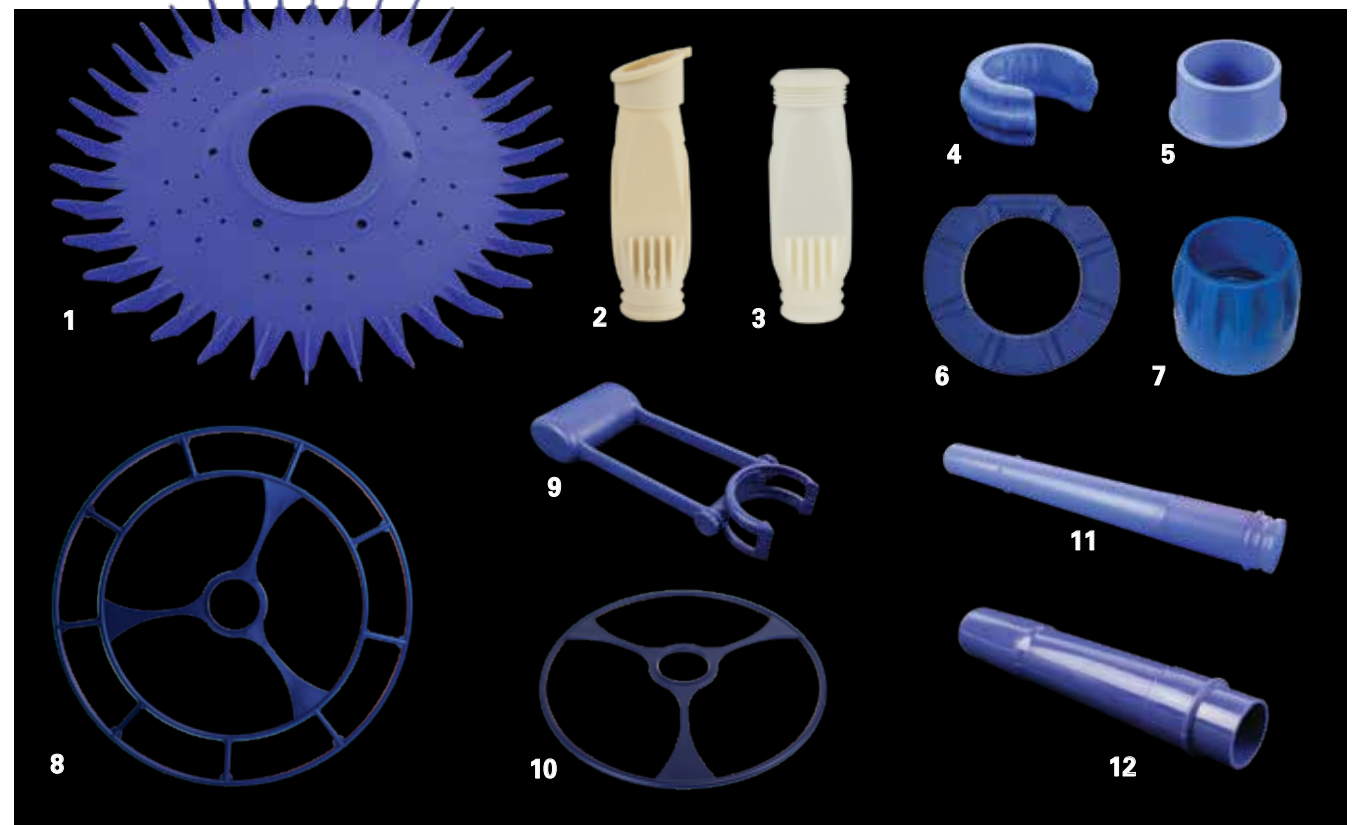

Creepy Krauly Parts

| | | |
|----|--------|-------------------------|
| 1 | CPC276 | Wearing Sole – Deluxe |
| 2 | CPC283 | Wing Set of 2 |
| 3 | CPC405 | Hose Motor |
| 4 | CPC415 | Baffle Plate |
| 5 | CPC420 | Swivel & Insert |
| 6 | CPC425 | Wrap Around Wings |
| 7 | CPC430 | Water Diverter |
| 8 | CPN276 | Wearing Sole – Standard |
| 9 | CPC435 | Hose Weight |
| 10 | CPC440 | Hammer |
| 11 | CPC270 | Pleated Seal – Deluxe |
| 12 | CPC255 | Bumper Strap |



Other APC Spares

| | | |
|---|--------|----------------------------------|
| 1 | CPB061 | Skimmer Weir Elbow 45 Degree |
| 2 | CPB049 | Inline Flow Valve – All Cleaners |
| 3 | CPB064 | Skimmer Weir Adaptor |

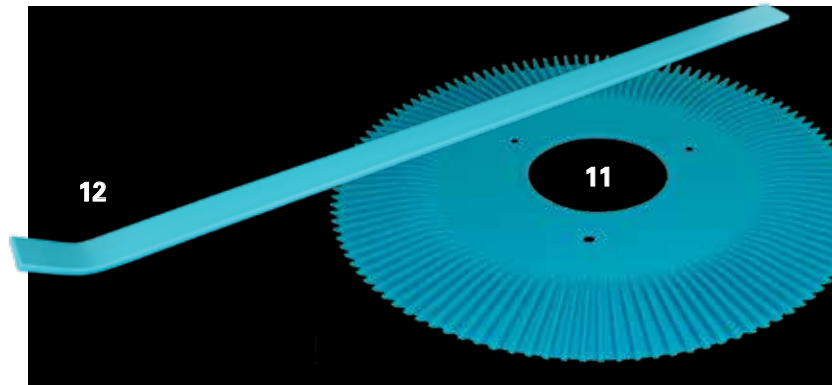

Poolvac Parts

| | | |
|---|------------|--------------------------------|
| 1 | AC-V604WHP | Wing Kit |
| 2 | AC-V434W | Flap Kit |
| 3 | AC-V417WHP | Foot Pod Kit |
| 4 | AC-V612D | Universal A-Frame Assembly Kit |
| 5 | AC-V014CP | Pod Shoe – Ceramic |
| 6 | AC-413P | Pod Shoe – Cork |
| 7 | AC-V414P | Pod Shoe – Concrete 4pk |
| 8 | AC-V602 | Turbine Bearing Kit |
| 9 | AC-BE | Elbow Suit Poolvac |

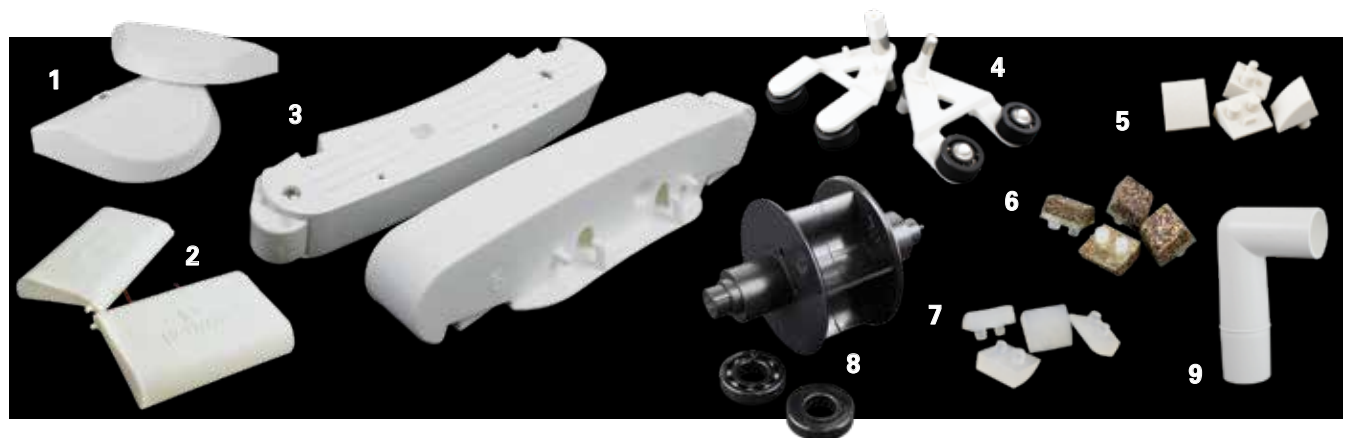

Zodiac Parts

| | | |
|----|------------|------------------------------|
| 1 | AB-81710 | Diaphragm - cassette |
| 2 | AB-81700 | Diaphragm - standard |
| 3 | AW-7230223 | Wheel Bearing 280/180 |
| 4 | AB-69785 | Medium Wheel |
| 5 | AB-70244 | 45 Degree Elbow |
| 6 | AB-69721 | Flexi Foot Pearl Blue |
| 7 | AW-7230105 | All Purpose Bag 280 |
| 8 | AW-7230210 | Maxtrax Tyre White |
| 9 | AB-81600 | Retaining Ring |
| 10 | AB-30217 | Leader Hose Adaptor Baracuda |
| 11 | AB-70281 | Ad Flow Valve Complete |
| 12 | AB-0166100 | Mx8 Track (2 pack) |
| 13 | AB-70263 | Weir Cuff Universal W-70263 |
| 14 | AB-74000 | Compression Ring |
| 15 | AB-73010 | Diaphragm Duralife |
| 16 | AB-69731 | Locking Collar Zodiac G2 |
| 17 | AB-0176700 | Global Quick Hose Connector |
| 18 | AB-70179 | Disc 36 Fin Pearl Blue |
| 19 | AW-7610000 | Polaris Superbag Zodiac |
| 20 | AW-7230245 | Sweep Hose Scrubber Polaris |
| 21 | AB-69720 | Large Wheel Deflector |

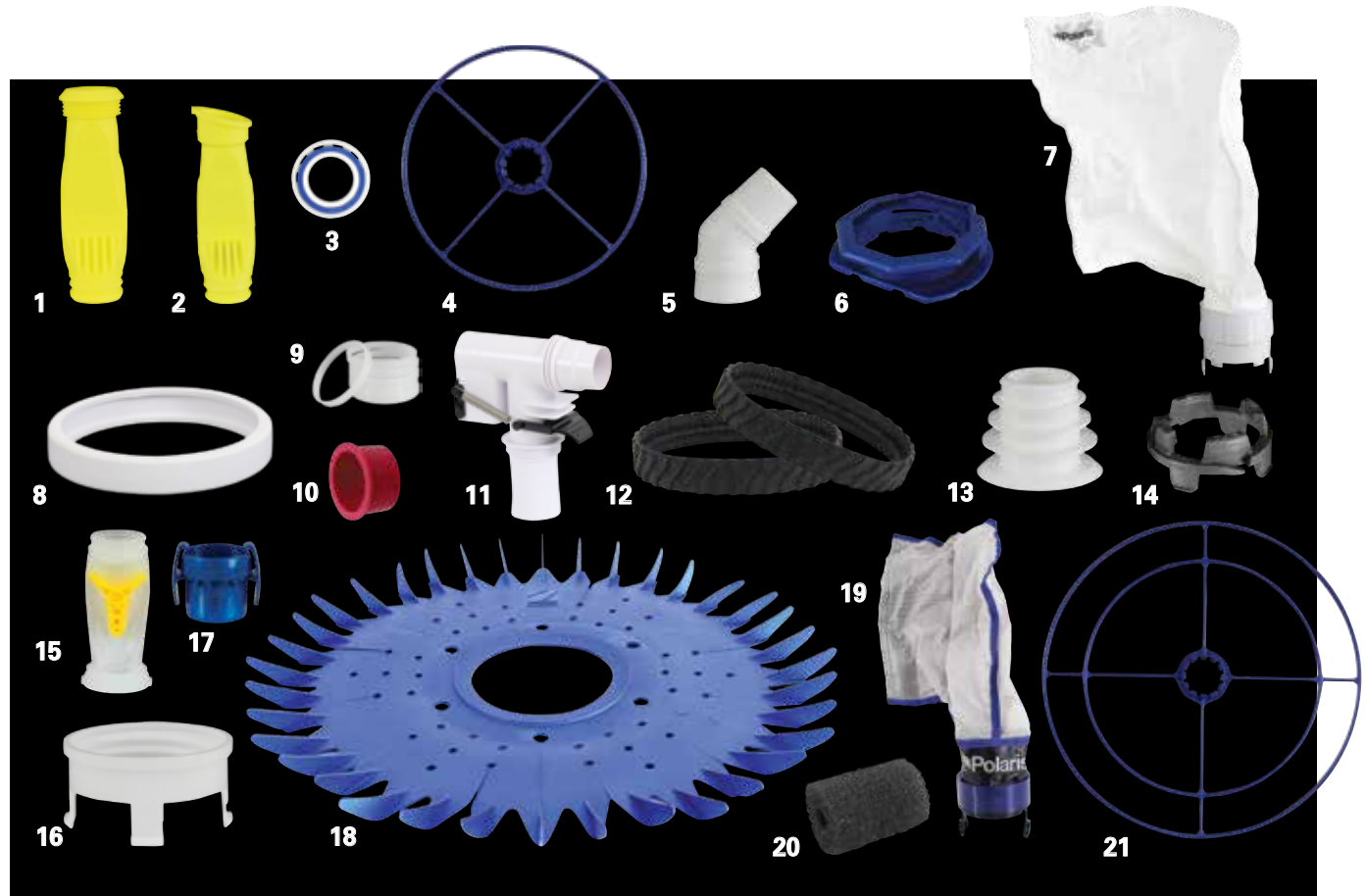
**Jetvac Parts**

| | | |
|---|---------|-------------------------------|
| 1 | AP-JV32 | Fine Silt Bag W I Ring Jetvac |
|---|---------|-------------------------------|

**Pentair Parts**

| | | |
|---|------------|-------------------------|
| 1 | AC-OGW7506 | GW 7500 Seal Flap Kit |
| 2 | AC-OGW7521 | GW 7500 Bumper Boot Kit |
| 3 | AC-OK6128 | Hammerhead Skirt |

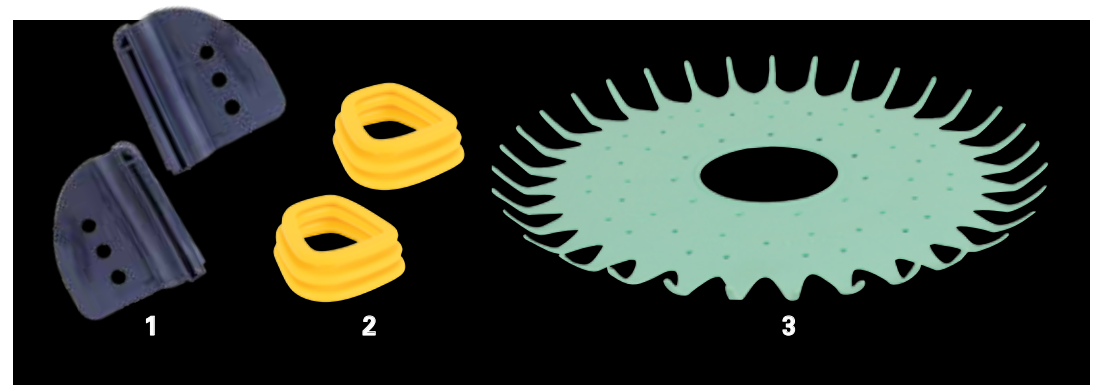

Pump Baskets

Suitable for:

| | | |
|----|---------|--------------------------------------|
| 1 | PU-BWSS | Waterco – Superstream |
| 2 | PBP008 | Onga 400/600 |
| 3 | PBP106 | Quiptron |
| 4 | PBP123 | Davey Powermaster |
| 5 | PBP134 | Davey XB, Powerace |
| 6 | PBP211 | Monarch – Espa / Espa Silent NS |
| 7 | PBP260 | Monarch – Typhoon |
| 8 | PBP287 | Monarch – Powerplus / Stroud NS MKII |
| 9 | PBP317 | Poolrite – SQI / PM Heavy Duty |
| 10 | PU-BWTT | Aquaswim 50 / 50T |
| 11 | PU-BWAS | Aquaswim Series 40 |
| 12 | PBP425 | Purex Aquatron |
| 13 | PBP451 | Astral Pool Hurlcon |
| 14 | PBP637 | Aquaswim/Speck – Large |
| 15 | PBP956 | Paramount Premier with Handle |
| 16 | PBP861 | Waterco – Supatuf MKII |
| 17 | PBP806 | Waterco – Fpi Charger/Duraflow 2 |



Skimmer Baskets Suitable for:

| | | |
|----|-------------|--|
| 1 | PBS472 | Clark – Inground WA72 |
| 2 | PBS580 | Poolrite – MKII S2500 |
| 3 | PBS610 | Filtrite – SK950 / SKB900 – Standard with Handle |
| 4 | PBS620 | Filtrite – SK950 / SKB900 – Heavy Duty |
| 5 | PBS630 | Filtrite – SK1000 with Handle |
| 6 | SK-B152 | Hayward – SP1083 / 1086 / 1082 |
| 7 | SK-B1088 | Hayward – SP1089 – Genuine with collar |
| 8 | SK-B1094 | Hayward – SP1094 / 1095 |
| 9 | PBS911 | Paramount/Swimworld/Vortex |
| 10 | PBS934 | Poolrite – S1800 |
| 11 | PBC025 | Poolrite Basket Cap |
| 12 | SK-BH | Hurlcon – large capacity skimmer |
| 13 | PBS466 | Clark – Weir / Bilnor |
| 14 | PBS214 | Baker Hydro/Purex |
| 15 | PBS230 | Poolstore – PS308 |
| 16 | SK-BU624024 | Waterco – Supaskimmer |
| 17 | PBS375 | Waterco – S75 MKII – lock down type |
| 18 | PBS753 | Waterco – S75/Nally SK103 |
| 19 | PBS962 | Quipton complete with handle |
| 20 | SK-BSTN | Stern Skimmer Basket SPSB-001F |
| 21 | SK-B11016 | Basket for 11001 Skimmer |





Filter Sock Discs

| | | |
|---|--------|---|
| 1 | MFD100 | Filter Sock Disc Suits Quiptron |
| 2 | MFD200 | Filter Sock Disc Suits Filtrite SK900 / SK950 |

| | | |
|---|--------|--|
| 3 | MFD300 | Filter Sock Disc Suits Poolrite 1800 / Waterco II |
| 4 | MFD400 | Filter Sock Disc Suits Poolrite S2500 / Waterco / Nally, Paramount |

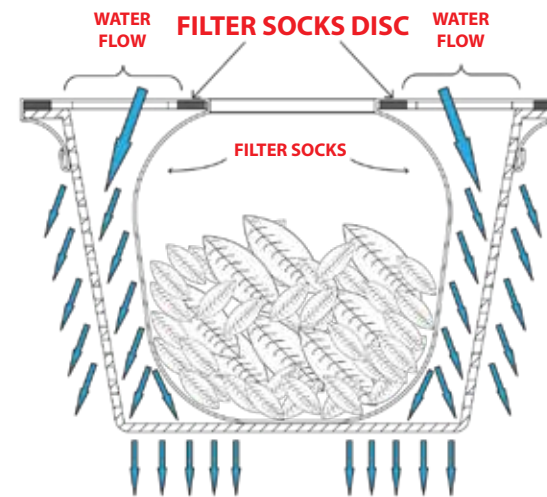
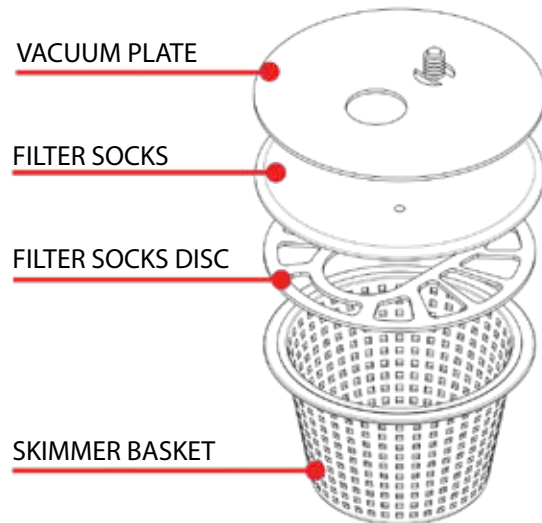

Aussie Gold Replacement Cartridges

A large selection of cartridges is stocked for all popular brands of equipment, including spas and hot tubs.

All cartridges are manufactured from high quality spun woven polyester fibre. This special fibre prevents dirt from becoming embedded in the material which makes cleaning fast and simple. Our Customer Service staff are pleased to provide additional assistance if you cannot identify the correct cartridge from the charts provided. All cartridges are individually boxed in a display carton complete with identification and barcode.

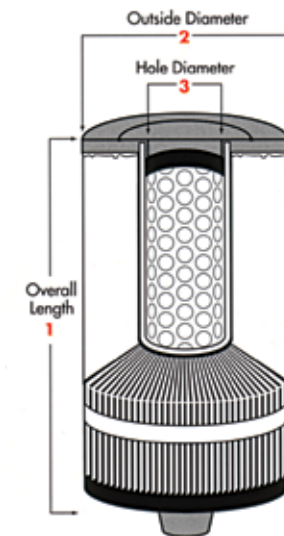

For easy identification first select the end cap style required and then match the measurement, starting with the overall length.

Replacement Cartridges Measurement Chart

| CODE | | NAME | | LENGTH | DIAMETER | TOP | BOTTOM | REMARKS |
|--|--|-----------------------------------|------|--------|----------|-------------|----------------|-------------------|
| AQUASWIM (Also Davey and Stroud older styles) | | | | | | | | |
| FC-AQ50 | | CF50 | | 370 | 185 | 75 | 75 | Open Both Ends |
| FC-AQ75 | | CF75 | | 550 | 185 | 75 | 75 | Open Both Ends |
| FC-AQ100 | | CF100 | | 730 | 185 | 75 | 75 | Open Both Ends |
| FC-AQ15/75 | | CF150 | each | 455 | 185 | 75 | 75 | Filter Requires 2 |
| ASTRAL TERRA (European Astral, Pre-Hurlcon) | | | | | | | | |
| FC-AS50 | | Terra 50 | | 260 | 228 | 95 | 95 | Open Both Ends |
| FC-AS75 | | Terra 75 | | 381 | 228 | 95 | 95 | Open Both Ends |
| FC-AS100 | | Terra 100 | | 500 | 228 | 95 | 95 | Open Both Ends |
| FC-AS150 | | Terra 150 | | 620 | 228 | 95 | 95 | Open Both Ends |
| BAKER HYDRO (Also Weir and Swimworld) | | | | | | | | |
| FC-BH25 | | HM 25/30 | | 250 | 175 | Knob Handle | Open Cone 52OD | |
| FC-BH50 | | HM 50 | | 489 | 175 | Knob Handle | Open Cone 52OD | |
| FC-BH75 | | HM 72/75 | | 744 | 175 | Knob Handle | Open Cone 52OD | |
| FC-BH100T | | HM 100 Top | | 489 | 180 | Knob Handle | 49 Hole | Best Bought |
| FC-BH100B | | HM 100 Bottom | | 489 | 180 | 59 Hole | Open Cone 52OD | As Set |
| FC-BH150T | | HM 150 Top | | 489 | 180 | Knob Handle | 49 Hole | Best Bought |
| FC-BH150B | | HM 150 Bottom | | 489 | 180 | 59 Hole | Open Cone 52OD | As Set |
| CAMEO SPA | | | | | | | | |
| FC-CAM | | Cameo Set of 2 | each | 120 | 125 | 54 | 54 | Open Both Ends |
| | | Clark Driklad | | | | | | |
| FC-AQC50 | | Turbo 550 / 50 | | 310 | 155 | 50 | 50 | Open Both Ends |
| FC-AQC75 | | Turbo 550 / 75 | | 450 | 155 | 50 | 50 | Open Both Ends |
| | | For cluster filters see Universal | | | | | | |
| DAVEY / QUESTA (For older style Davey see Aquaswim) | | | | | | | | |
| FC-D500 | | Easy Clear 500 | | 275 | 210 | 102 | 102 | Open Both Ends |
| FC-D750 | | Easy Clear 750 | | 275 | 230 | 102 | 102 | Open Both Ends |
| FC-D1000 | | Easy Clear 1000 | | 372 | 230 | 102 | 102 | Open Both Ends |
| FC-D1500 | | Easy Clear 1500 | | 562 | 230 | 102 | 102 | Open Both Ends |
| FC-D60/230 | | Mytilus 230 | | 354 | 205 | 75 | 77 | Open Both Ends |
| FC-D100/380 | | Mytilus 380 | | 563 | 205 | 75 | 77 | Open Both Ends |

Replacement Cartridges Measurement Chart

| CODE | | NAME | | LENGTH | DIAMETER | TOP | BOTTOM | REMARKS |
|--|--|----------------|---------------|--------|----------|----------------|-----------------------|-------------------|
| DIMENSION ONE | | | | | | | | |
| FC-DM40/36 | | 40 SQ FT | | 385 | 118 | Closed With | oD40 / ID23 | Bottom |
| FC-DM75new | | 75 SQ FT | Coarse Thread | 267 | 180 | Semi Circle | oD48 / ID30 | Threaded |
| FC-DM75old | | 75 SQ FT | Fine Thread | 267 | 180 | Handle | oD58 / ID44 | Spigot |
| FC-DM75TY | | 75 SQ FT | | 267 | 180 | 6mm W Y Stands | OD50 | Bottom Twist Lock |
| eMAUX (rebranded by many) | | | | | | | | |
| FC-EMX50 | | 50 SQ FT | | 358 | 185 | 77 | 77 | Open Both Ends |
| FC-EMX75 | | 75 SQ FT | | 538 | 185 | 77 | 77 | Open Both Ends |
| FC-EMX100 | | 100 SQ FT | | 718 | 185 | 77 | 77 | Open Both Ends |
| FC-EMX150 | | 150 SQ FT | | 898 | 185 | 77 | 77 | Open Both Ends |
| FILTERMASTER | | | | | | | | |
| FC-FM25 | | C25 | | 223 | 185 | 75 | 75 | Open Both Ends |
| FC-FM50 | | C50 | | 477 | 185 | 75 | 75 | Open Both Ends |
| FC-FM75 | | C75 | | 716 | 185 | 75 | 75 | Open Both Ends |
| FINSBURY (For Finsbury Compact see Rainbow) | | | | | | | | |
| FC-FB50 | | C50 | | 484 | 185 | Closed | 60OD / 50ID Male Slip | |
| FC-FB75 | | C75 | | 484 | 185 | Closed | 60OD / 50ID Male Slip | |
| FC-FB100 | | C100 | | 494 | 206 | Closed | 60OD / 50ID Male Slip | |
| FC-FS | | Splasher | | 119 | 136 | Closed | 55OD / 47ID Male Slip | |
| | | FPI | | | | | | |
| FC-FP25 | | C25 | | 240 | 185 | 75 | 75 | Open Both Ends |
| FC-FP50 | | C50 | | 495 | 185 | 75 | 75 | Open Both Ends |
| FC-FP75 | | C75 | | 743 | 185 | 75 | 75 | Open Both Ends |
| FILTRITE | | | | | | | | |
| FC-FT5000 | | Turbo 5000 | | 377 | 122 | 54 | 54 | Open Both Ends |
| HAYWARD (Also Sternflow) | | | | | | | | |
| FC-H225 | | C120,C200,C225 | | 297 | 115 | 54 | 54 | Open Both Ends |
| FC-H250 | | C250 | | 250 | 178 | 76 | 76 | Open Both Ends |
| FC-H400 | | C400 | | 270 | 215 | Closed Handle | 103 | |
| FC-H410 | | C410 | | 357 | 177 | 76 | 76 | Open Both Ends |
| FC-H500 | | C500 | Also C570 | 500 | 178 | 76 | 76 | Open Both Ends |

Replacement Cartridges Measurement Chart

| CODE | NAME | LENGTH | DIAMETER | TOP | BOTTOM | REMARKS |
|---|--------------------------------|-------------|----------|--------------------------------|--------|----------------------|
| HAYWARD (Also Sternflow) (continued) | | | | | | |
| FC-H750 | C750 | 748 | 178 | 76 | 76 | Open Both Ends |
| FC-H800 | C800 | 442 | 215 | 103 | 103 | Open Both Ends |
| | C1500 | 2 x FC-H800 | | | | |
| FC-H850 | C850 | 357 | 235 | 75 | 76 | Open Both Ends |
| FC-H870 | C870 | 648 | 177 | 76 | 76 | Open Both Ends |
| FC-H900 | C900 | 442 | 225 | 102 | 102 | Open Both Ends |
| FC-H1100 | C1100 | 595 | 215 | 102 | 102 | Open Both Ends |
| FC-H1200 | C1200 | 595 | 225 | 102 | 102 | Open Both Ends |
| FC-H1250 | C1250 | 499 | 235 | 76 | 76 | Open Both Ends |
| FC-H1750 | C1750 | 712 | 225 | 102 | 102 | Open Both Ends |
| | C3025 | 4 x FC-H500 | | | | |
| HOT SPRINGS | | | | | | |
| FC-HS25 | 25 / 30 SQ FT | 262 | 150 | 50 | 50 | Open Both Ends |
| FC-HS50 | 50 / 65 SQ FT | 267 | 215 | 76 | 76 | Open Both Ends |
| HURLCON QX (For older see Waterco Trimline, for even older see Aquaswim) | | | | | | |
| FC-HQX50 | 50 SQ FT | 370 | 185 | 75 | 75 | Open Both Ends |
| FC-HQX75 | 75 SQ FT | 495 | 185 | 75 | 75 | Open Both Ends |
| FC-HQX100 | 100 SQ FT | 495 | 185 | 75 | 75 | Open Both Ends |
| FC-HQX150 | 150 SQ FT | 744 | 185 | 75 | 75 | Open Both Ends |
| | GX400/CL400 = 4 x FC-HQX100 | | | GX600/CL600 = 4 x FC-HQX150 | | |
| HURLCON ZX | | | | | | |
| FC-HZ50 | 50 SQ FT | 288 | 230 | 75 | 75 | Open Both Ends |
| FC-HZ75 | 75 SQ FT | 288 | 230 | 75 | 75 | Open Both Ends |
| FC-HZ100 | 100 SQ FT | 488 | 230 | 75 | 75 | Open Both Ends |
| FC-HZ150 | 150 SQ FT | 488 | 230 | 75 | 75 | Open Both Ends |
| FC-HZ200 | 200 SQ FT | 688 | 230 | 75 | 75 | Open Both Ends |
| FC-HZ250 | 250 SQ FT | 688 | 230 | 75 | 75 | Open Both Ends |
| FC-HZ300 | 300 SQ FT | 890 | 230 | 75 | 75 | Set of 2 with Joiner |

Replacement Cartridges Measurement Chart

| CODE | NAME | LENGTH | DIAMETER | TOP | BOTTOM | REMARKS |
|---|---------------|-----------|-----------|---------------|----------------|---------------------------|
| INTEX | | | | | | |
| PCI008 | | 200 | 110 | 50 | 50 | Open Both Ends |
| JACUZZI | | | | | | |
| FC-J25 | 25 SQ FT | 338 | 125 | 60 | 60 | No Core |
| FC-J50 | 50 SQ FT | 255 | 255 | 146 | 153 | No Core |
| JAZZI SPA | | | | | | |
| FC-JAZ25 | 25 SQ FT | 173 | 142 | Closed | 59OD / 43ID | Fine Thread Spigot |
| KRYSTAL KLEAR | | | | | | |
| FC-KK8 | 8 SQ FT | 200 | 110 | 50 | 50 | Open Both Ends |
| L A SPA | | | | | | |
| FC-LA36 | 36 SQ FT | 375 | 118 | Closed With | OD46 / ID35 | Fine Thread 40BSP Spigot |
| FC-LA50 | 45 SQ FT | 205 / 225 | 145 / 152 | Semi Circle | OD46 / ID35 | Fine Thread 40BSP Spigott |
| FC-LA50/85 | 45 SQ FT | 216 | 127 | Handle | OD85 / ID54 | Fine Thread Spigot |
| LEISURE-RITE | | | | | | |
| FC-LR50 | 50 SQ FT | 444 | 125 | 53 | 53 | Open Both Ends |
| MONARCH SPA | | | | | | |
| FC-MS45 | 45 SQ FT | 203 | 142 | Closed | OD46 / ID39 | Fine Thread 40BSP Spigot |
| NALLY | | | | | | |
| FC-NA75 | Astra P2519 | 295 | 297 | Closed Knob | 36ID Spout | |
| FC-NA150 | Astra P2520 | 500 | 297 | Closed Knob | 36ID Spout | |
| FC-NM25 | Mono 25 | 230 | 173 | Closed Knob | 73OD Male Slip | |
| FC-NM50 | Mono 50 P2526 | 430 | 173 | Closed Knob | 73OD Male Slip | |
| FC-NM75 | Mono 75 P1516 | 490 | 185 | Closed Knob | 73OD Male Slip | |
| O2 SPA (Escape, Rising Dragon, Arctic, Maax) | | | | | | |
| FC-O2/24 | 24 SQ FT | 203 | 125 | Closed | OD46 / ID39 | Fine Thread 40BSP Spigot |
| FC-O2/50 | 50 SQ FT | 339 | 127 | Closed Handle | OD60 / ID46 | Coarse Internal Thread |
| ONGA / PENTAIR | | | | | | |
| FC-OS25 | FCP 25 | 250 | 177 | 76 | 76 | Open Both Ends |
| FC-OS6000 | FCP 6000 | 485 | 185 | 76 | 76 | Open Both Ends |

Replacement Cartridges Measurement Chart

| CODE | NAME | LENGTH | DIAMETER | TOP | BOTTOM | REMARKS |
|---|------------------------|--------------------|----------|-----|--------|----------------------------|
| ONGA / PENTAIR continued | | | | | | |
| FC-OS9000 | FCP 9000 | 485 | 185 | 76 | 76 | Open Both Ends |
| FC-OS6000BR | BR 6000 / LCF60 | 495 | 185 | 75 | 75 | Open Both Ends |
| FC-OS9000BR | BR 9000 / LCF90 | 495 | 185 | 75 | 75 | Open Both Ends |
| FC-Q464 | Pantera PCF 50/60 | 370 | 185 | 75 | 75 | Open Both Ends |
| FC-Q696 | Pantera PCF 75 | 495 | 185 | 75 | 75 | Open Both Ends |
| FC-Q929 | Pantera PCF 100 | 744 | 185 | 75 | 75 | Open Both Ends |
| | Pantera PCF 150 | 2 x FC-Q696 | | | | |
| FC-HQX75 | Pantera PCF II 75 | 495 | 185 | 75 | 75 | Open Both Ends |
| FC-HQX100 | Pantera PCF II 100 | 495 | 185 | 75 | 75 | Open Both Ends |
| FC-HQX150 | Pantera PCF II 150 | 744 | 185 | 75 | 75 | Open Both Ends |
| FC-PCF200 | Pantera PCF II 200 | 744 | 185 | 75 | 75 | Open Both Ends |
| FC-OR173572 | Clean & Clear Plus 240 | 359 | 177 | 76 | 76 | Each 60 SQ FT - Require 4 |
| FC-OR173573 | Clean & Clear Plus 320 | 508 | 177 | 76 | 76 | Each 80 SQ FT - Require 4 |
| FC-OR173576 | Clean & Clear Plus 420 | 662 | 177 | 76 | 76 | Each 105 SQ FT - Require 4 |
| FC-OR173578 | Clean & Clear Plus 520 | 815 | 177 | 76 | 76 | Each 130 SQ FT - Require 4 |
| | Pampa Spa | | | | | |
| FC-PS25 | 25 SQ FT | 250 | 170 | 50 | 44 | Raised Lips |
| FC-BH25 | 25 SQ FT Old Style | use Baker Hydro 25 | | | | |
| PARAMOUNT OPAL (Also old Bowman) | | | | | | |
| FC-P50 | HC50 (Old) | 360 | 206 | 96 | 96 | Open Both Ends |
| FC-PO85 | C85 | 430 | 255 | 75 | 75 | Open Both Ends |
| FC-PO110 | C110 | 430 | 255 | 75 | 75 | Open Both Ends |
| FC-PO150 | C150 | 430 | 255 | 75 | 75 | Open Both Ends |
| FC-PO180 | C180 | 425 | 255 | 75 | 75 | Open Both Ends |

Replacement Cartridges Measurement Chart

| CODE | NAME | LENGTH | DIAMETER | TOP | BOTTOM | REMARKS |
|--|--|--------|----------|---------------|---------------------------|-----------------|
| PARAMOUNT OPAL continued (Also old Bowman) | | | | | | |
| FC-PR80 | CL80 | 720 | 185 | 56 | 75 | Top Collar |
| POOLRITE (For cluster filters see Universal) | | | | | | |
| | CL110 = 2 x FC-PR55 | | | | | |
| FC-PR30 | CL30 | 266 | 185 | 74 | 75 | Top Collar |
| FC-PR55 | CL55 | 490 | 185 | 74 | 75 | Top Collar |
| FC-PR80 | CL80/CL100 | 713 | 185 | 74 | 75 | Top Collar |
| | CL110 = 2 x FC-PR55 | | | | | |
| FC-E50 | EC50 Enduro | 370 | 185 | 75 | 75 | Open Both Ends |
| FC-E75 | EC75 | 370 | 185 | 75 | 75 | Open Both Ends |
| FC-E100 | EC100 | 550 | 185 | 75 | 75 | Open Both Ends |
| FC-E150 | EC150 | 730 | 185 | 75 | 75 | Open Both Ends |
| FC-PRWM110 | 110 Watermizer LOWER in 240 Tank | 292 | 230 | 102 | Slip Fitting 50ID / 100OD | |
| FC-PRWM130 | 130 Single in 130 Tank, or Upper in 240 Tank | 368 | 230 | Closed Castle | Slip Fitting 50ID / 100OD | |
| FC-PRWM200L | 200 LOWER in the 400 Tank only | 295 | 295 | 100 | Slip Fitting 60ID / 100OD | |
| FC-PRWM200U | 200 UPPER in 400 Tank, or Single in 200 Tank | 355 | 295 | Closed Castle | Slip Fitting 60ID / 100OD | |
| POOLSTORE | | | | | | |
| FC-PST80 | 80 SQ FT (780) | 455 | 177 | Knob | Cone 44 ID | |
| FC-PST100 | 100 SQ FT (7100) | 705 | 177 | Knob | Cone 44 ID | |
| FC-PST130 | 130 SQ FT (7130 / 7160) | 705 | 177 | Knob | Cone 44 ID | |
| FC-PST110 | 110 SQ FT Older Style | 744 | 177 | Knob | Cone 44 ID | |
| PRIDE | | | | | | |
| FC-PD40 | 40 SQ FT | 320 | 130 | 36 | 48 | Collar Each End |
| QUIPTRON (For old style see FPI) | | | | | | |
| FC-Q464 | Quiptron 464 | 370 | 185 | 75 | 75 | Open Both Ends |
| FC-Q696 | Quiptron 696 | 495 | 185 | 75 | 75 | Open Both Ends |

Replacement Cartridges Measurement Chart

| CODE | | NAME | | LENGTH | DIAMETER | TOP | BOTTOM | REMARKS |
|--|--|----------------------------------|--|-----------|----------|-----------------|-------------|----------------------|
| QUIPTRON continued (For old style see FPI) | | | | | | | | |
| FC-Q464 | | Quiptron 464 | | 370 | 185 | 75 | 75 | Open Both Ends |
| FC-Q696 | | Quiptron 696 | | 495 | 185 | 75 | 75 | Open Both Ends |
| FC-Q929 | | Quiptron 929 | | 744 | 185 | 75 | 75 | Open Both Ends |
| | | Quiptron 1500 = 2 x FC-Q696 | | | | | | |
| RAINBOW DYNAMICS / WATERWAYS | | | | | | | | |
| FC-R10 | | RDC 10 | | 120 | 125 | 54 | 54 | Open Both Ends |
| FC-R25 | | RDC 25 | | 340 | 125 | 54 | 54 | Open Both Ends |
| FC-R50 | | RDC 50 | | 340 | 125 | 54 | 54 | Open Both Ends |
| FC-R75 | | RTL 75 | | 510 | 125 | 54 | 54 | Open Both Ends |
| | | RDC 100 = 2 x FC-R50 | | | | | | |
| FC-DSF35 | | DSF 35 SQ FT set of 2 | | each 115 | 129 | 54 | 54 | Comes As Set Of 2 |
| FC-DSF50 | | DSF 50 SQ FT set of 2 | | each 165 | 129 | 54 | 54 | Comes As Set Of 2 |
| FC-DSF75 | | DSF 75 SQ FT / Waterco Top Load | | 600 | 129 | 54 | 54 | Open Both Ends |
| FC-DFW75 | | Waterways Dynaflo 75 | | 380 | 135 | 54 | 54 | Open Both Ends |
| FC-WW100 | | Waterways 100 (2 Interlocked) | | total 425 | 145 | Closed Handle | OD49 / ID38 | Coarse Thread Spigot |
| SIGNATURE | | | | | | | | |
| FC-SG25B | | 25 SQ FT Bullfrog | | 146 | 203 | 48 w 2 Lugs | OD56 / ID52 | Coarse Thread Spigot |
| FC-SG50B | | 50 SQ FT Bullfrog | | 146 | 203 | Closed Handle | OD56 / ID52 | Coarse Thread Spigot |
| PCS650 | | 45 SQ FT Short | | 205 | 145 | Closed Handle | OD47/ID38 | Coarse Thread Spigot |
| FC-SG45 | | 45 SQ FT Long | | 225 | 145 | Closed Handle | OD47 / ID38 | Coarse Thread Spigot |
| FC-SG100 | | 100 SQ FT | | 223 x 2 | 145 | Interlocked Set | OD47 / ID38 | Coarse Thread Spigot |
| FC-SG25N | | 25 SQ FT Fits Nature 2 Spa Stick | | 223 | 145 | 48 w 2 LUGS | OD47 / ID38 | Coarse Thread Spigot |
| SPA INTERNATIONAL | | | | | | | | |
| FC-SII40 | | C40 | | 254 | 127 | Closed Handle | 44 | Internal Thread |
| SPA 2 GO | | | | | | | | |
| FC-SPA2GO | | 8 SQ FT | | 200 | 116 | 54 | 54 | Open Both Ends |

Replacement Cartridges Measurement Chart

| CODE | | NAME | | LENGTH | DIAMETER | TOP | BOTTOM | REMARKS |
|--|--|--|------|--------|----------|-----|--------|-------------------|
| SPA QUIP (Also Aquaswim and older styles Davey and Stroud) | | | | | | | | |
| FC-AQ50 | | C500 | | 370 | 185 | 75 | 75 | Open Both Ends |
| FC-AQ75 | | C750 | | 550 | 185 | 75 | 75 | Open Both Ends |
| FC-AQ100 | | C1000 | | 730 | 185 | 75 | 75 | Open Both Ends |
| FC-AQ15/75 | | C1500 | each | 455 | 185 | 75 | 75 | Filter Requires 2 |
| FC-AQC50 | | CC50 Compact | | 300 | 155 | 50 | 50 | Open Both Ends |
| FC-AQC75 | | CC75 Compact | | 450 | 155 | 50 | 50 | Open Both Ends |
| SPA QUIP 1000 SERIES - spa and skim-filter cartridges | | | | | | | | |
| FC-SQ50 | | C1050 | | 300 | 145 | 52 | 52 | Open Both Ends |
| FC-SQ75 | | C1075 | | 448 | 145 | 52 | 52 | Open Both Ends |
| FC-SQ1040 | | Spa Skim-Filter (2) | | 138 | 145 | 52 | 52 | Open Both Ends |
| | | Spa Skim-Filter Widemouth SQ1240 use 2 x FC-SG45 | | | | | | |
| FC-SQSKIM50 | | 50 SQ FT Skim-Filter | | 226 | 145 | 52 | 52 | Open Both Ends |
| | | 100 SQ FT Skim-Filter use 2 x FC-SQSKIM50 | | | | | | |
| SPA QUIP 2000 SERIES (Also suit Poolrite Enduro, Monarch EcoPure) | | | | | | | | |
| FC-E50 | | C2050 | | 370 | 185 | 75 | 75 | Open Both Ends |
| FC-E75 | | C2075 | | 370 | 185 | 75 | 75 | Open Both Ends |
| FC-E100 | | C2100 | | 550 | 185 | 75 | 75 | Open Both Ends |
| FC-E150 | | C2150 | | 730 | 185 | 75 | 75 | Open Both Ends |
| STARITE | | | | | | | | |
| FC-S50 | | PTM50 | | 340 | 222 | 105 | 105 | Top Hole Has One |
| FC-S70 | | PTM70 | | 464 | 222 | 105 | 105 | Straight Edge |
| FC-S100 | | PTM100 | | 654 | 222 | 105 | 105 | No Centre Core |
| FC-S135 | | PTM135 | | 794 | 222 | 105 | 105 | Double Filter |
| STERN see Hayward or Sunflow | | | | | | | | |

Replacement Cartridges Measurement Chart

| CODE | NAME | LENGTH | DIAMETER | TOP | BOTTOM | REMARKS |
|---|-----------------------------|--------|----------|------------------|-----------------------|------------------------|
| STROUD for clamp style see Waterco Trimline, for old steel tank see Paramount, for lock ring style see Aquaswim | | | | | | |
| SUNDANCE | | | | | | |
| FC-SND65 | 65 SQ FT | 380 | 190 | Closed Castle | 67 | |
| FC-SND80 | 80 SQ FT | 354 | 214 | Closed Collar | 77 / 63 Slope Hole | Top Coarse Collar 63OD |
| FC-SND90 | 90 SQ FT | 480 | 178 | 46 MPT Thread | 77 / 63 Slope Hole | |
| FC-SND100 | 100 SQ FT | 470 | 214 | Closed Castle | 77 / 63 Slope Hole | |
| FC-SND125SLIP | C125 SLIP FIT | 483 | 214 | ID38 / Male Slip | 77 / 63 Slope Hole | |
| FC-SND125STEP | C125 3 STEP | 451 | 214 | 3 Step | 77 / 63 Slope Hole | |
| SUNFLOW | | | | | | |
| FC-SF15 | 1500 | 120 | 145 | Closed | 38 | Closed One End |
| FC-SF30 | 3000 | 272 | 145 | Closed | 38 | Closed One End |
| FC-SF50 New | 5000 | 272 | 145 | Closed | 38 | Closed One End |
| FC-SF50 Old | 5000 | 410 | 145 | Closed | 38 | Closed One End |
| FC-SF75 | 7500 | 410 | 145 | Closed | 38 | Closed One End |
| SWIMWORLD see Baker Hydro and Paramount for older styles | | | | | | |
| WATERCO TRIMLINE (also old Hurlcon range) | | | | | | |
| FC-W25 | C25 | 240 | 185 | 77 | 77 | Open Both Ends |
| FC-W50 | C50 | 496 | 185 | 77 | 77 | Open Both Ends |
| FC-W75 | C75 | 745 | 185 | 77 | 77 | Open Both Ends |
| FC-W50C | CC50 compact | 370 | 185 | 77 | 77 | Open Both Ends |
| FC-W75C | CC75 compact | 493 | 185 | 77 | 77 | Open Both Ends |
| FC-W100C | CC100 compact | 740 | 185 | 77 | 77 | Open Both Ends |
| | CC150 compact = 2 x FC-W75C | | | | | |
| WATERCO MULTICYCLONE | | | | | | |
| FC-WA40MC | 40 SQ FT | 197 | 160 | 53 | 53 | Open Both Ends |
| FC-WA75MC | 75 SQ FT | 380 | 160 | 53 | 53 | Open Both Ends |

Replacement Cartridges Measurement Chart

| CODE | NAME | LENGTH | DIAMETER | TOP | BOTTOM | REMARKS |
|---|--------------------|--------|----------|--------|--------|----------------|
| WATERCO FULFLO (for old style Nally and Astra Fulflo - see Nally) | | | | | | |
| FC-WF100 | 90 SQ FT | 230 | 305 | 78 | 78 | Open Both Ends |
| FC-WF200 | 180 / 200 SQ FT | 440 | 305 | 78 | 78 | Open Both Ends |
| WATERCO TRI SERIES | | | | | | |
| FC-WT100 | TC300 Uses 3 x 100 | 790 | 155 | 50 | 50 | Open Both Ends |
| FC-WT134 | TC400 Uses 3 x 134 | 790 | 155 | 50 | 50 | Open Both Ends |
| FC-WT167 | TC500 Uses 3 x 167 | 790 | 155 | 50 | 50 | Open Both Ends |
| WATERWAYS see Rainbow & Signature | | | | | | |
| DE CONVERSION | | | | | | |
| FC-DE20/100 | 100 SQ FT | 404 | 260 | Closed | Cone | |
| FC-DE32/150 | 150 SQ FT | 625 | 260 | Closed | Cone | |
| UNIVERSAL, HARMSCO | | | | | | |
| FC-U6/190 | 6 SQ FT | 190 | 70 | 27 | 27 | Open Both Ends |
| FC-U6/250 | 6 SQ FT | 244 | 70 | 27 | 27 | Open Both Ends |
| FC-U12 | 12 SQ FT | 444 | 70 | 27 | 27 | Open Both Ends |

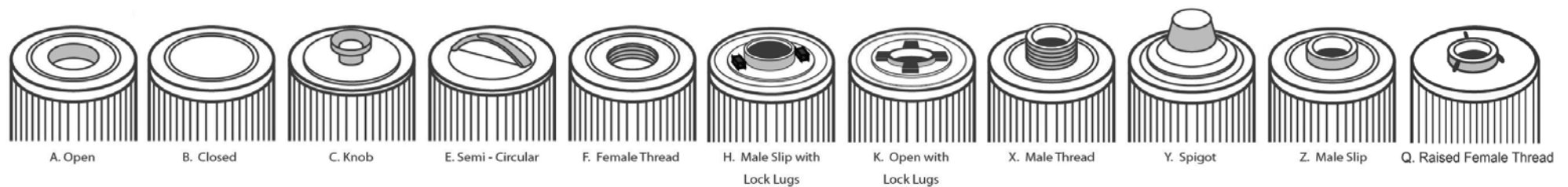

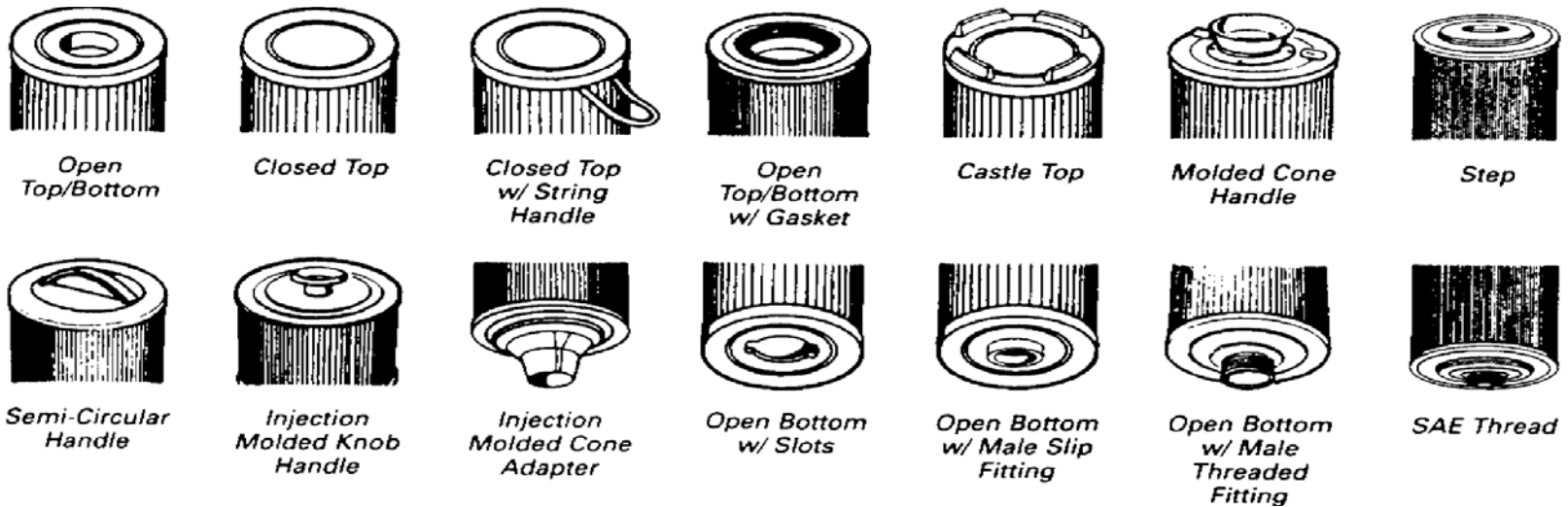

MEASUREMENTS CAN VARY BECAUSE:

- Cartridges collapse slightly with age and use
- Different manufacturers over the years
- Errors due to the actual people who make up the sizing charts
- Different methods used for measuring - rulers are not that precise

IDENTIFICATION:

| | | | |
|--------------------------------|-----------|------------|---------------|
| Top | Hole Size | Collar | Closed |
| Bottom | Hole Size | Spout Slip | Spigot Thread |
| And of course length and width | | | |

TERMS

| | |
|--------|------------------------------|
| BSP | British Standard Pipe |
| NPT | National Pipe Thread (USA) |
| MPT | Male Pipe Thread |
| SAE | Society Automotive Engineers |
| ID | Internal Diameter |
| OD | Overall Diameter |
| FEMALE | Internal |
| MALE | External |

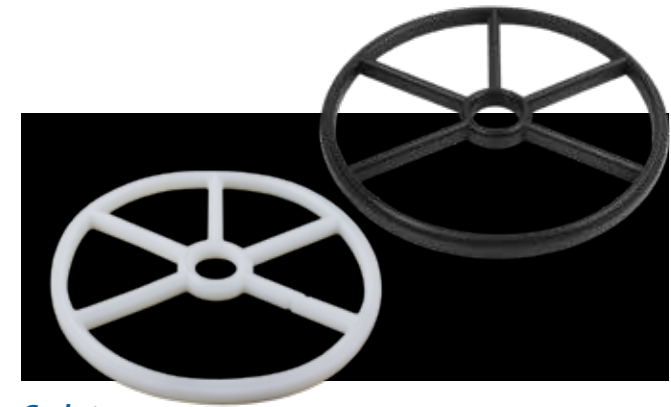

Flexible Connectors

| | | | |
|---|--------|---------------------------|-------------|
| 1 | FFC505 | Flexi Connect | 50mm |
| 2 | FFC404 | Flexi Connect | 40mm |
| 3 | FFC504 | Flexi Connect | 40mm x 50mm |
| 4 | FFC449 | Flexi Connect Elbow 90Deg | 40mm |

Flexible Connectors are made from the highest quality neoprene compound.

Hose Clamps

| | | |
|--------|------------------------------|------|
| FHC440 | Hose Clamp Quick Release 2pk | 40mm |
| FHC450 | Hose Clamp Quick Release 2pk | 50mm |

Quick Release Hose Clamps are super fast to fit and remove. Perfect for both the service person and the pool owner.

Gaskets

| | | |
|---------|---------------------------------------|------|
| PGV040 | Eco Pure/Reliance MKIII | 40mm |
| PGV050 | Eco Pure/Reliance MKIII | 50mm |
| PGV670 | Spider Hurlcon | 40mm |
| PGV673 | Spider Hurlcon/Praher 2" | 50mm |
| PGV740 | Spider 5 spoke | 40mm |
| PGV742 | Spider Poolrite V800 (old style) | 50mm |
| PGV746 | Spider Poolrite V600 (thin new style) | 50mm |
| PGV753 | Spider Hayward Sp-715 5 spoke | 50mm |
| PGV764 | Spider Hayward Sp-710D 6 spoke | 40mm |
| PGW094 | Spider Waterco Post 94 | 40mm |
| V-MDSG4 | Midas Spider Gasket | 40mm |

We stock all popular gaskets to suit all major Multiport Valves. Please check our current Price List or contact Customer Care for complete details.



O-rings

| | | |
|---|--------|--|
| 1 | MOK100 | Imperial O-ring Kit – (382 O-rings), 30 individual sizes |
| 2 | MOK300 | Metric O-ring Kit – (401 O-rings), 34 individual sizes |

An extensive range of O-rings is available to fit most popular brands of equipment. Each O-ring is professionally presented for easy in-store identification and display. Pool Systems also carries complete service person O-ring Kits designed specially for the industry professional. Please check our current Price List for a full list of O-rings.

Cartridge Lids

| | | | |
|---|----------|--|-------|
| 1 | F-LM6304 | Monarch Clearflow – P4 | 235mm |
| 2 | PLC080 | Spa Quip, Poolrite, Enduvo, Davey, Hurlon, Stroud & Aquaswim – 2000 series | 215mm |
| 3 | F-W62025 | Waterco – Trimline MKII | 220mm |



Pump Lids

| | | | |
|---|----------------|------------------------------------|-------------------|
| 1 | PLP011 | Onga – 400 / 600 Series Screw Type | |
| 2 | PLP485 | Hurlcon TX / CX / CTX / Eco Pump | 162mm int dia |
| 3 | PU-LDV | Davey – Powermaster | 155mm dia |
| 4 | PU-LWTT | Waterco – Pump lid | 150mm dia |
| 5 | PU-LME11000506 | Monarch Silent MKII Typhoon | 120mm dia |
| 6 | PU-LWAQ | Waterco – Aquastream Post 98 | 130mm dia |
| 7 | PLP880 | Poolrite – PM | 160mm x 138mm dia |
| 8 | PLP906 | Paramount – Premier | 180mm dia |

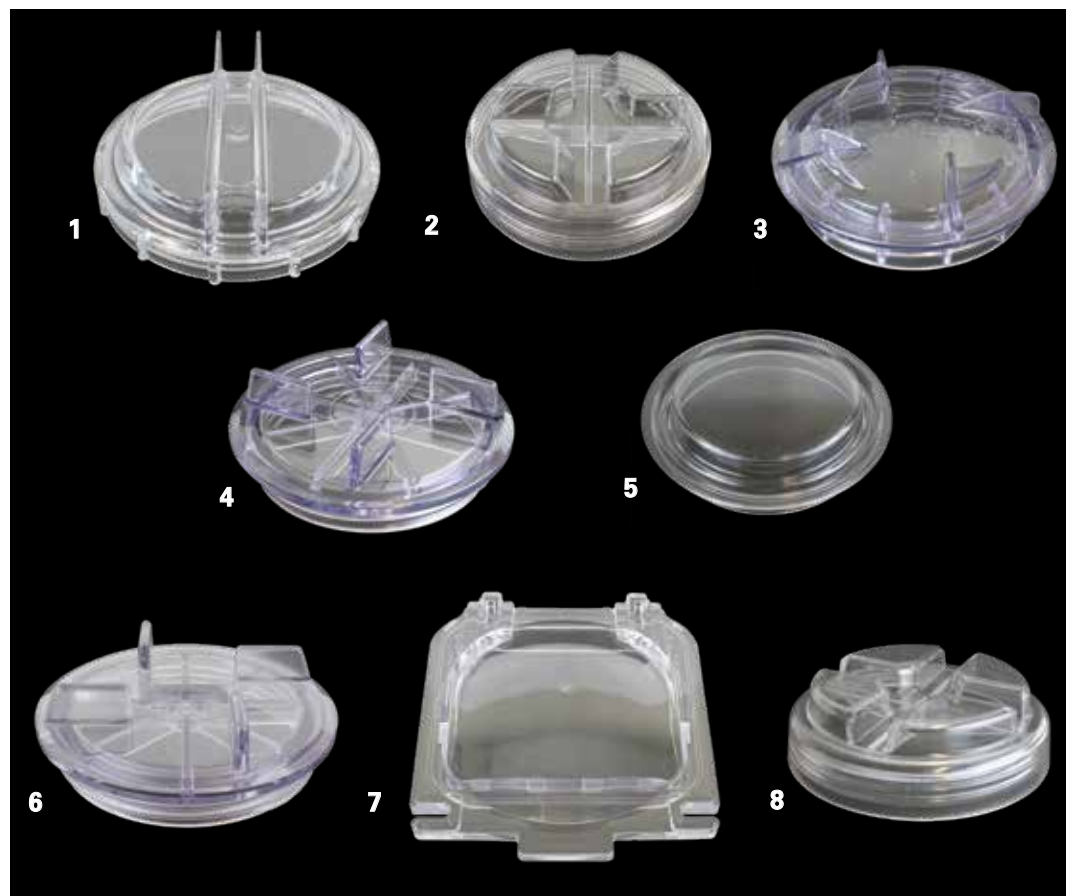



Deck Lids

| | | | |
|----|-------------|-------------------------|--------------------------|
| 1 | PLS813 | Filtrite – SKB950 | O/D – 270mm SLIP – 242mm |
| 2 | PLS819 | Filtrite – SKB950 | O/D – 270mm SLIP – 242mm |
| 3 | PMF100 | Multi Fit White | |
| 4 | PSS270 | Baker Hydro | O/D – 251mm SLIP – 231mm |
| 5 | PSS863 | Paramount/ Swimworld | O/D – 270mm SLIP – 242mm |
| 6 | SK-DL62411S | Waterco Sandstone | O/D – 300mm SLIP - 270mm |
| 7 | SK-PLS380 | Poolrite | O/D – 269mm |
| 8 | PLS258 | Clark Inground/WA72 | O/D – 250mm SLIP – 212mm |
| 9 | PLS511 | Waterco SK104 | O/D – 300mm SLIP – 270mm |
| 10 | PLS809 | Filtrite – SKB900 | O/D – 270mm SLIP – 229mm |



Dress Rims

| | | | |
|---|---------|-------------------|------------|
| 1 | SK-DRQW | Filtrite – SKB950 | 242mm SLIP |
| 2 | SK-DRQB | Filtrite – SKB950 | 242mm SLIP |
| 3 | PSS272 | Baker Hydro | 226mm SLIP |

Main Drain Covers

| | | | |
|---|------------|--|-----------|
| 1 | FMD415 | White Dome | 295mm dia |
| 2 | PSM495 | Quiptron/Dega - White, Cover & Dress Rim, concrete | 210mm dia |
| 3 | PL-O801012 | Dega New Style - White | 265mm dia |
| 4 | PL-PR1504 | Poolrite Anti-Vortex Cover | 235mm dia |
| 5 | PL-W29303 | Waterco Maindrain Cover & Ring White | 225mm dia |
| 6 | FMD280 | White Aussie Gold - Concrete | 240mm dia |
| 7 | FMD285 | Blue Aussie Gold | 240mm dia |
| 8 | FMD300 | White Aussie Gold Low Profile, Fibreglass | 240mm dia |
| 9 | PL-W29313 | Grease Plate & Lid Waterco | |

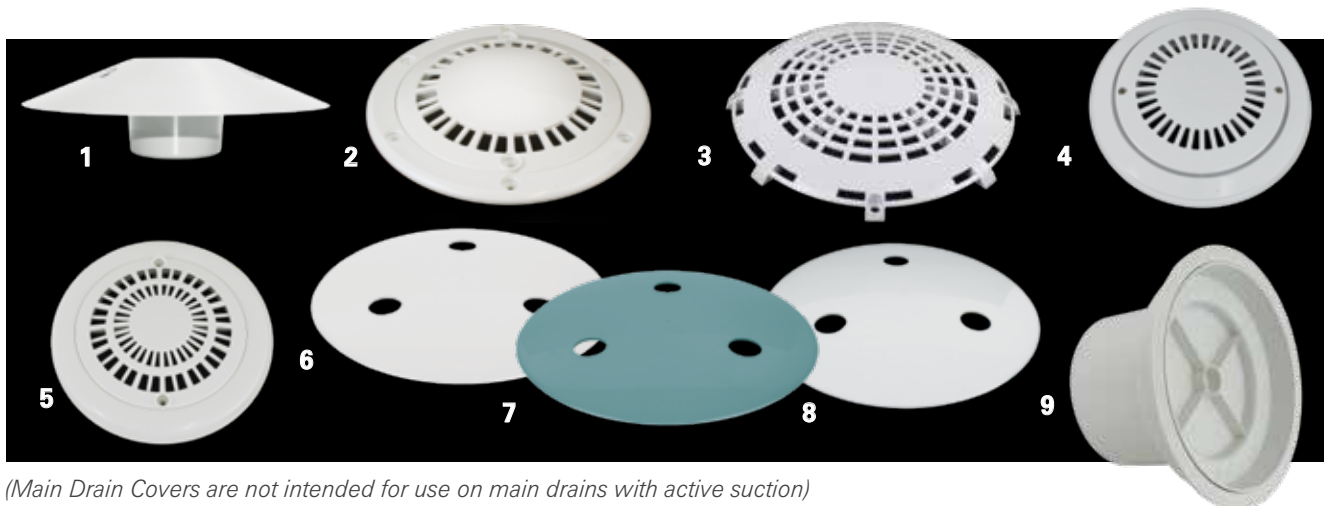

(Main Drain Covers are not intended for use on main drains with active suction)

These universal fitting covers are concrete filled to maximise weight. Designed to prevent all suction cleaners from becoming stuck on original grate style covers.

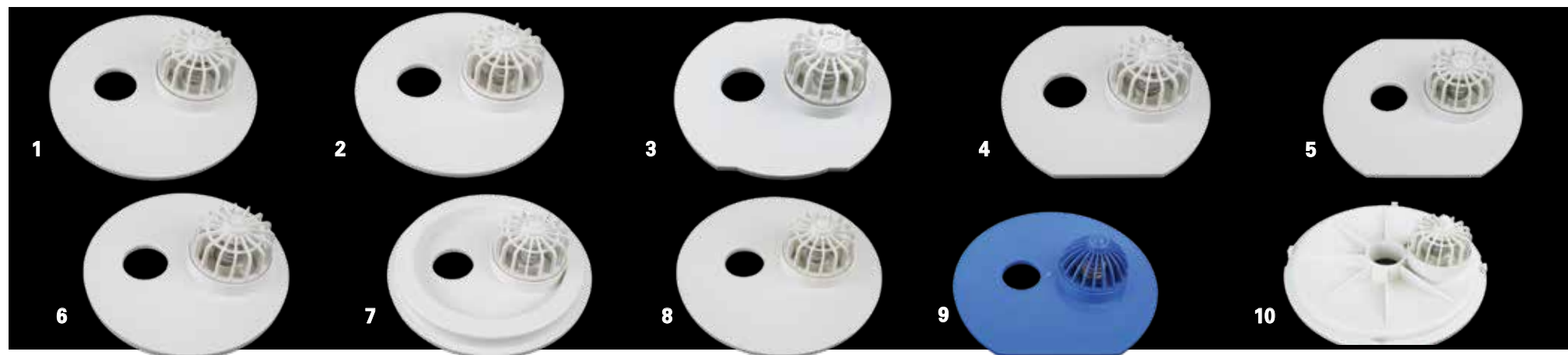

Skimtrol Plates Suitable for:

| | | | |
|---|----------|------------------------------------|---------------|
| 1 | SK-SKBH | Baker Hydro/Purex & Poolrite S2500 | 224mm |
| 2 | SK-SKC | Clark WA72 Inground/Swimquip | 215mm |
| 3 | SK-SK900 | Filtrite SK900 (Cut to Cut 210m) | 228mm |
| 4 | SK-SK950 | Filtrite SK950 | 217mm x 192mm |
| 5 | SK-SKN | Nally/Fulflo | 245mm x 213mm |

| | | | |
|----|---------|--------------------------------------|-------|
| 6 | SK-SKP | Paramount / F.P.I. | 208mm |
| 7 | SK-SKPR | Poolrite S1800 | 229mm |
| 8 | SK-SKQ | Quiptron | 241mm |
| 9 | SK-SKW | Waterco S75 MKI | 242mm |
| 10 | SK-SKW3 | Waterco Supaskimmer /Hurlcon (4 Lug) | 270mm |

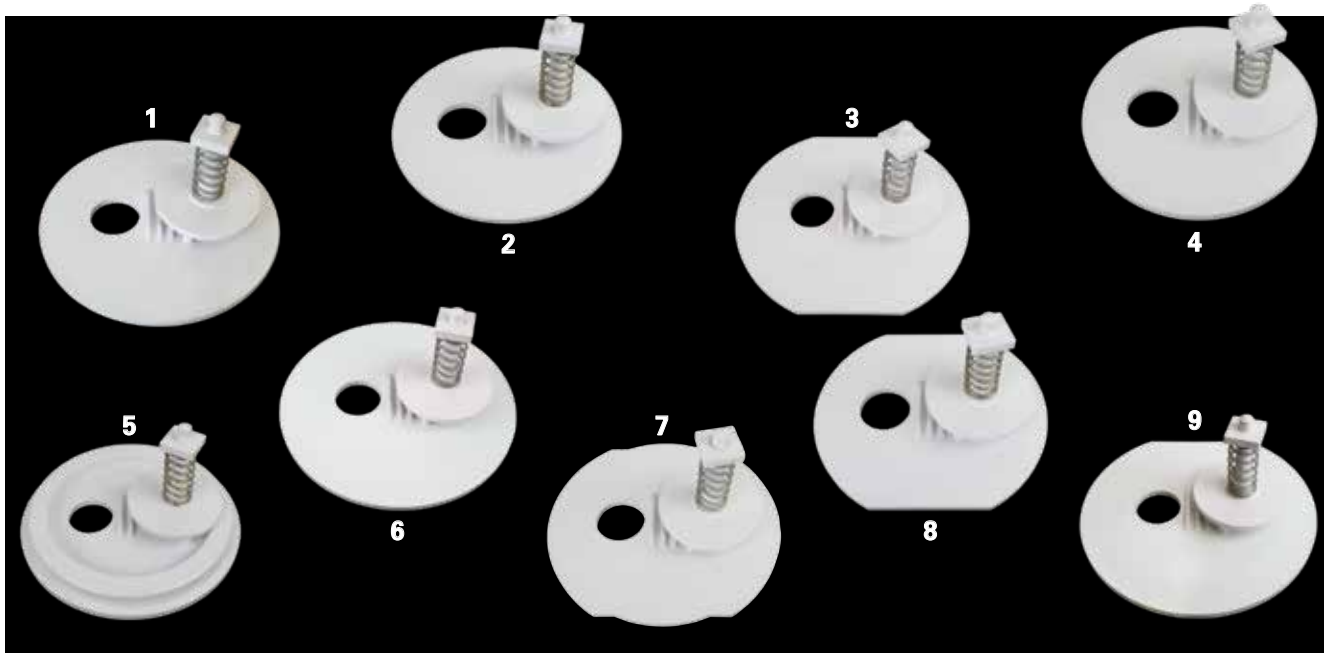

Vactrol Plates Suitable for:

| | | | |
|---|-----------|------------------------------------|-------|
| 1 | SK-VACBH | Baker Hydro/Purex & Poolrite S2500 | 224mm |
| 2 | SK-VACC | Clark WA72 Inground / Swimquip | 214mm |
| 3 | SK-VACN | Nally / Fulflo | 244mm |
| 4 | SK-VACPM | Paramount / F.R.I. | 208mm |
| 5 | SK-VACPR | Poolrite S1800 | 229mm |
| 6 | SK-VACQ | Quiptron | 240mm |
| 7 | SKVAC900 | Filtrite SK900 | 225mm |
| 8 | SK-VAC950 | Filtrite SK950 | 214mm |
| 9 | SK-VACW | Waterco MKI, MKII, S75 | 245mm |

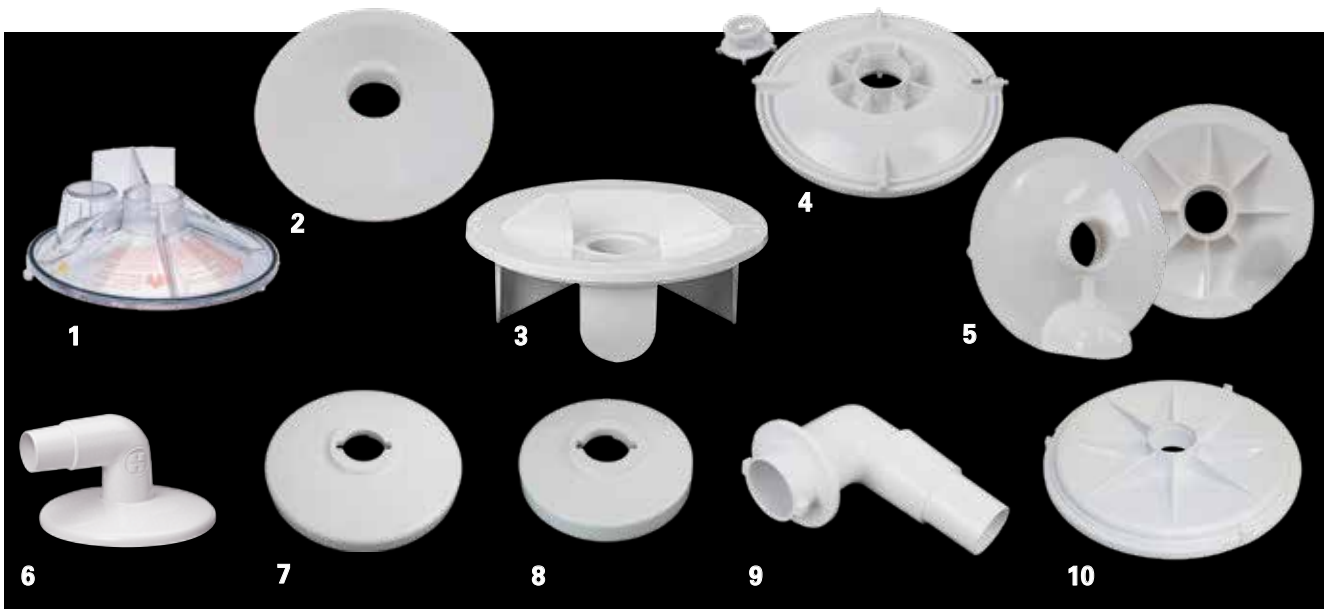

Vacuum Plates Suitable for:

| | | | |
|----|------------|-------------------------------|-------|
| 1 | PVP124 | Baker Hydro/Purex | 220mm |
| 2 | SK-VPC2 | Clark Inground/WA72, Swimquip | 215mm |
| 3 | PVP414 | Filtrite – SKB950/SKB952 | 220mm |
| 4 | PVP468 | Quiptron | 243mm |
| 5 | PVP479 | Filtrite – SKB900/SKB910 | 220mm |
| 6 | SK-VP10940 | Hayward – SP1094-D | 139mm |
| 7 | PVP525 | Hayward SP1107-A | 186mm |
| 8 | PVP552 | Hayward – SP1104-A | 150mm |
| 9 | PVP564 | Hayward Elbow 90 Degree | |
| 10 | PVP558 | Waterco – S75 | 270mm |

Vacuum Plates continued overleaf >

Vacuum Plates Suitable for:

| | | | |
|----|--------------|-----------------------------------|-------------------|
| 11 | SK-VPW624084 | Waterco – Supaskimmer | 275mm dia |
| 12 | PVP780 | Poolrite – S1800 | 230mm dia |
| 13 | PVP795 | Poolrite – S2500 1 Hole | 238mm dia |
| 14 | SK-VP025 | Paramount | 216mm dia |
| 15 | PVP798 | Valve Auto Control Poolrite S2500 | |
| 16 | PVP796 | Vacuum Plate S2500 Two Hole | 230mm dia |
| 17 | SKVPAQ | Swimline /Aquaswim Vac Plate | 200mm dia |
| 18 | SK-VPBN | Blue Haven/ Driclad | 203mm dia |
| 19 | SK-VPZ5314 | Zodiac 2005 Skimmer | 171mm x 285mm dia |
| 20 | SK-VP11012 | 11001 Skimmer | 160mm dia |

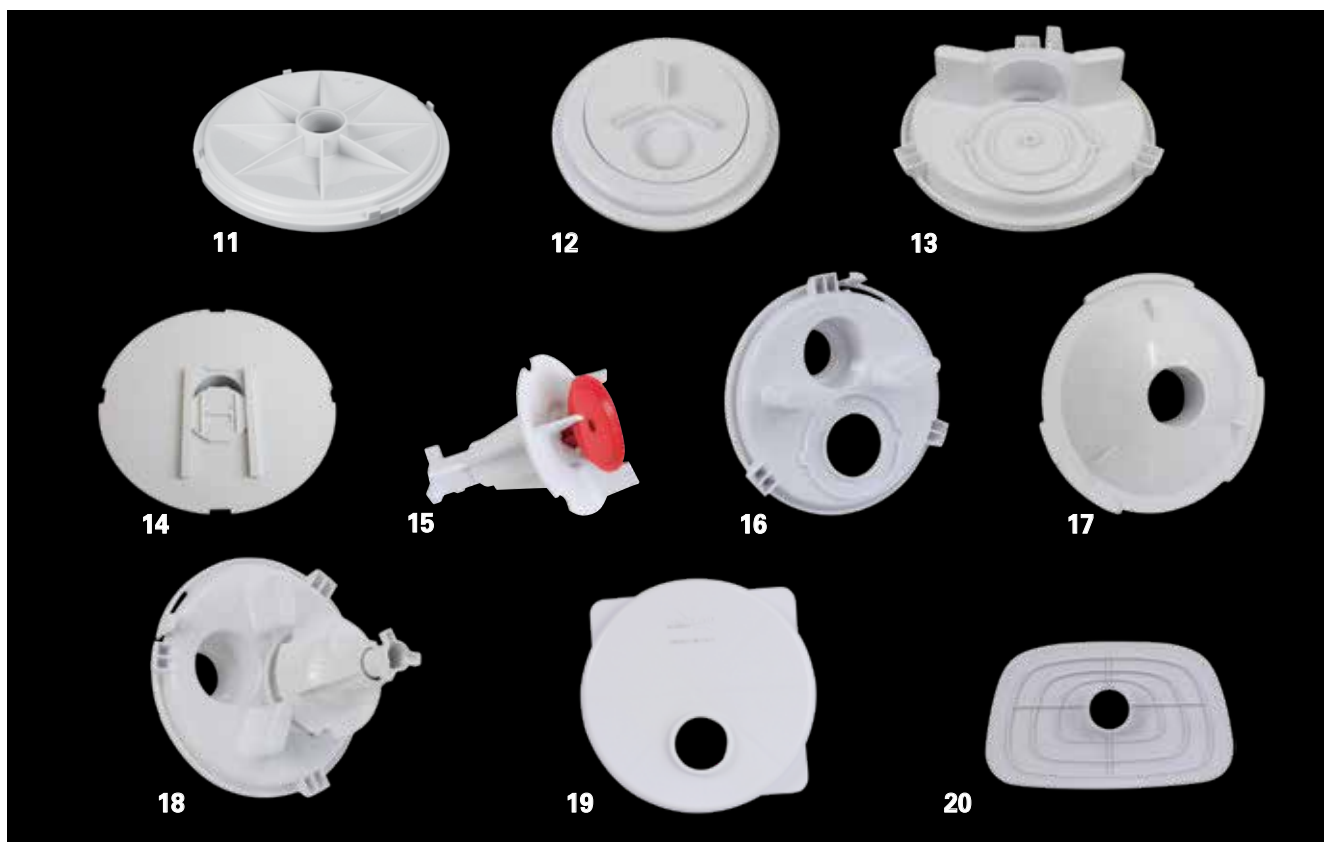

Transformers

| | | |
|---|---------|-------------------------|
| 1 | LI-LV25 | Transformer Single 25VA |
| 2 | LI-LV50 | Transformer Dual 50VA |



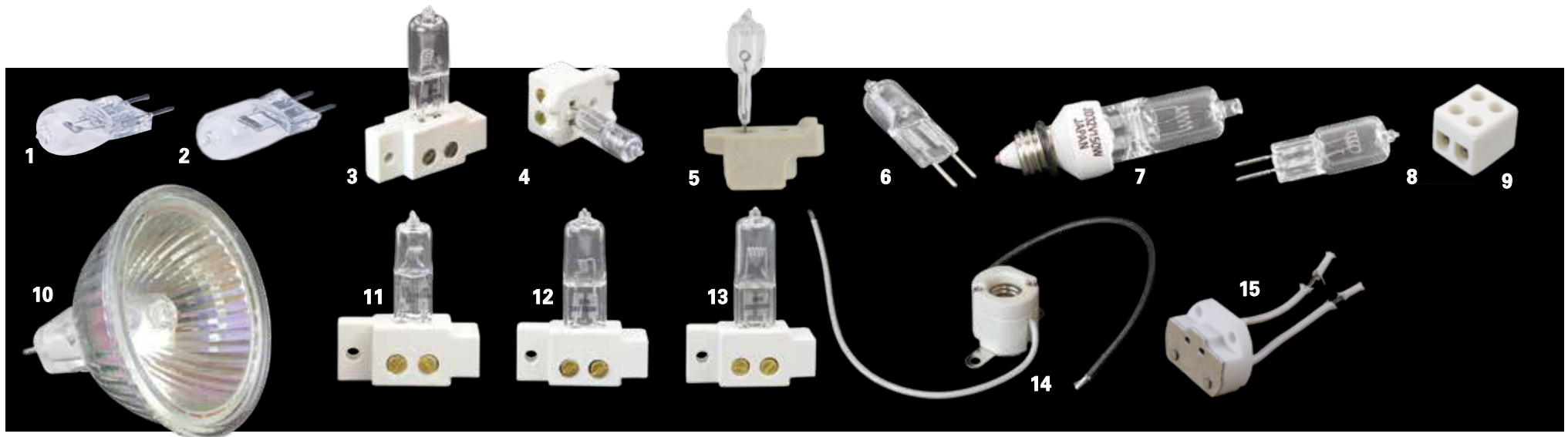

Globes and Accessories

| | | |
|---|----------|--------------------------------|
| 1 | PSL243 | Swimworld – 12V, 100W – 2 pin |
| 2 | PSL259 | Waterco/Poolrite – 24V, 150W |
| 3 | PSL274 | Spa Electrics – 22V, 24V, 150W |
| 4 | PSL278 | Spa Electrics – 12V, 100W |
| 5 | LI-WN207 | 12V Globe, Connector & Gasket |
| 6 | PSL314 | Waterco – 24V, 100W – 2 pin |

| | | |
|----|-------------|---------------------------------------|
| 7 | LI-AQSG | Stroud – 32V, 150W – Screw |
| 8 | PSL292 | Stroud – 32V, 150W – 2 pin |
| 9 | PSL304 | Waterco – Ceramic Terminal Block |
| 10 | LI-39-2DL50 | Powerite PAL-2000 50w Xenon Lamp |
| 11 | PSL412 | Spa Electrics – 12V, 100W – GK Series |
| 12 | PSL424 | Spa Electrics – 24V, 100W – GK Series |

| | | |
|----|--------|---------------------------------------|
| 13 | PSL432 | Spa Electrics – 32V, 150W – GK Series |
| 14 | PSL290 | Stroud – Globe Holder – Screw |
| 15 | PSL370 | Stroud – Globe Holder – 2 pin |



Pressure Gauges

| | | |
|---|--------|-----------------------------------|
| 1 | PPG411 | Lower Mount Stainless Steel |
| 2 | PPG415 | Centre Back Mount Stainless Steel |
| 3 | PPG421 | Lower Mount Liquid Filled |
| 4 | PPG422 | Centre Back Mount Liquid Filled |
| 5 | PPG500 | Lower Mount Plastic |
| 6 | PPG504 | Centre Back Mount Plastic |



Lenses

| | | | |
|---|-----------|---|-----------|
| 1 | LI-WN201B | Spa Electrics – Lens Cap – Blue – WN Series | 110mm dia |
| 2 | LI-WN201C | Spa Electrics – Lens Cap – Clear – WN Series | 110mm dia |
| 3 | LI-301BL | Spa Electrics – Lens Cap – Blue – SE3 Series | 170mm dia |
| 4 | LI-301BC | Spa Electrics – Lens Cap – Clear – SE3 Series | 170mm dia |
| 5 | LI-GK601C | Spa Electrics – Lens Cap – Clear – GK Series | 172mm dia |

| | | | |
|---|-----------|---|-----------|
| 6 | LI-GK601B | Spa Electrics – Lens Cap – Blue – GK Series | 172mm dia |
| 7 | LI-39-2CB | Lens Blue Pal 2000 | 90mm dia |
| 8 | LI-39-2CC | Lens Clear Pal 2000 | 90mm dia |
| 9 | LI-301-BL | Clip on Lens - Blue - SE3 Series | 175mm dia |

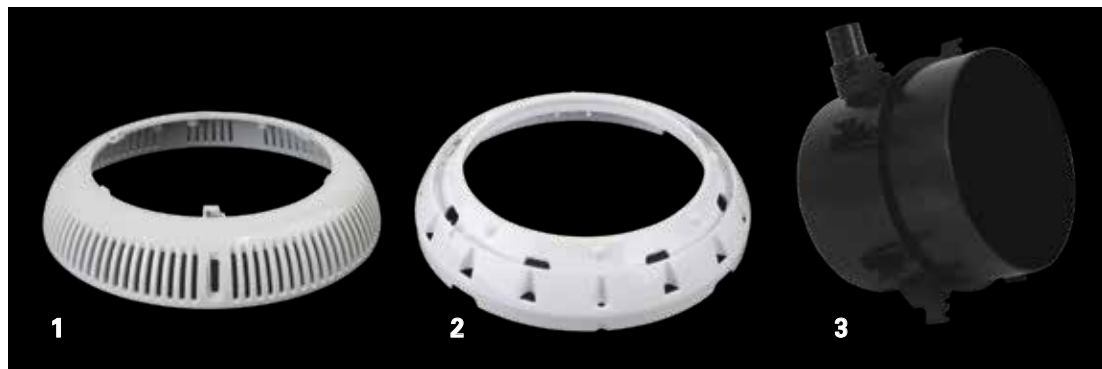

Rims & Mounting

| | | |
|---|------------|--|
| 1 | LI-304W | Spa Electrics – Lens Cap – White – SE3 Series |
| 2 | LI-GK6704W | Spa Electrics – Lens Cap – White – GK Series – Slotted |
| 3 | LI-WN208 | Mounting Kit Concrete Niche |

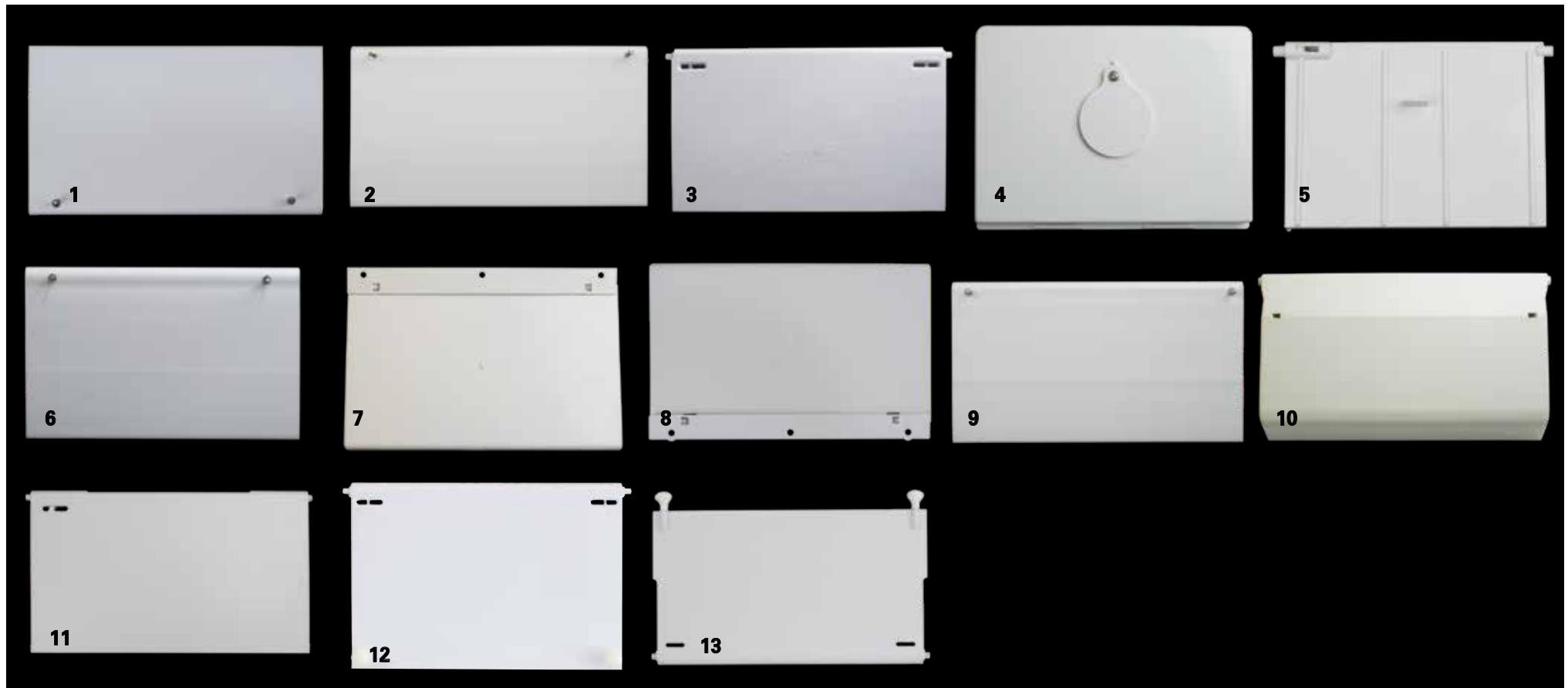

Weir Doors Suitable for:

| | | | |
|---|--------|------------------------------------|---------------|
| 1 | PWD109 | Filtrite – SKB900 Spring Loaded | 130mm x 228mm |
| 2 | PWD195 | Filtrite – SKB950 Spring Loaded | 128mm x 240mm |
| 3 | PWD307 | Waterco | 145mm x 243mm |
| 4 | PWD310 | Filtrite – SK1000 (Alternative) | 170mm x 252mm |

| | | | |
|---|--------|--|---------------|
| 5 | PWD405 | Clark Weir WA72 | 128mm x 175mm |
| 6 | PWD472 | Clark Inground / WA72 Spring Loaded | 130mm x 210mm |
| 7 | PWD509 | Filtrite – SKB900 | 130mm x 228mm |
| 8 | PWD595 | Filtrite – SKB950 | 128mm x 240mm |
| 9 | PWD703 | Baker Hydro/Purex Spring Laded | 130mm x 239mm |

| | | | |
|----|--------|--------------------|---------------|
| 10 | PWD826 | Paramount | 145mm x 230mm |
| 11 | PWD513 | Quiptron Weir Door | 145mm x 245mm |
| 12 | PWD280 | Poolrite S1800 | 163mm x 237mm |
| 13 | PWD295 | Poolrite S2500 | 135mm x 240mm |



Weir Door Spares

| | | |
|---|--------|--------------------------------|
| 1 | PDC118 | Weir Door Hinge Pin – Poolrite |
| 2 | PDC348 | Weir Door Hinge Pin – Waterco |

| | | |
|---|--------|-----------------------------|
| 3 | PSS614 | Weir Door Catch – SK1000 |
| 4 | PSS635 | Quiptron Latch Assembly (2) |

| | | |
|---|-----------|---------------------------------|
| 5 | SK-WH1000 | Filtrite SK1000 Weir Hinges (2) |
|---|-----------|---------------------------------|

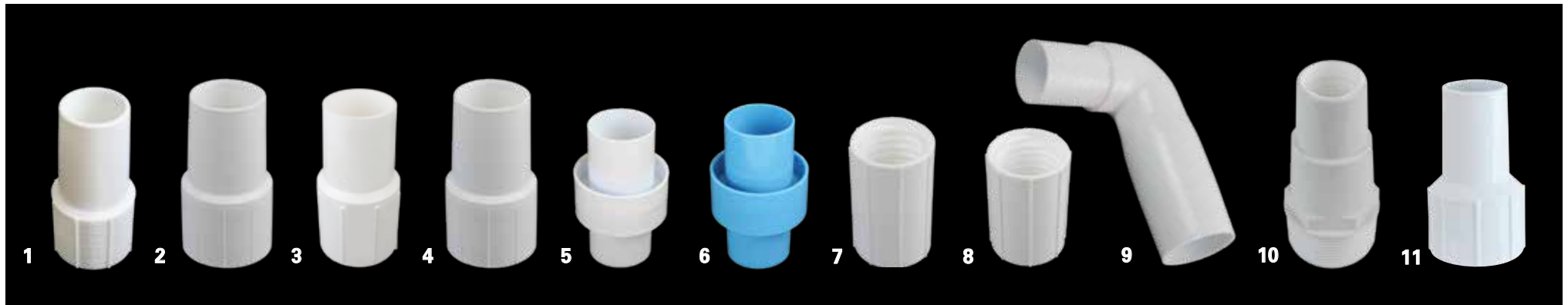

Vacuum Hose Spares

| | | |
|---|--------|------------------------|
| 1 | CJB132 | Hose Cuff LHT 32mm |
| 2 | CJB138 | Hose Cuff LHT 38mm |
| 3 | CJB150 | Hose Cuff Barfell 50mm |
| 4 | CJP038 | Hose Cuff 38mm |

| | | |
|---|--------|---------------------------|
| 5 | CJB301 | Hose Joiner 38mm White |
| 6 | CJX038 | Hose Joiner 38mm Blue |
| 7 | CJX132 | Hose Joiner Threaded 32mm |
| 8 | CJX138 | Hose Joiner Threaded 38mm |

| | | |
|----|--------|------------------------|
| 9 | CJB179 | Elbow Cuff 90 Degree |
| 10 | FHA328 | Hose Adaptor 32mm/38mm |
| 11 | CJB332 | Hose Cuff 32/38mm |

Cleaning Equipment Spares

| | | |
|----|------------|--|
| 1 | CPV529 | Handle – Vacuum Heads |
| 2 | CPR530 | Handle – Leaf Rake & Scoop |
| 3 | CPR750 | Net – Super Leaf Rake White Polyester |
| 4 | CPR754 | Net – Leaf Rake & Shovel White polyester |
| 5 | BR-LRKRN-M | Magnor Leaf Rake Repl Net |
| 6 | CPS756 | Net – Leaf Scoop White |
| 7 | CPT715 | Cam Set Screw Type – External |
| 8 | CPT709 | Cam Set – Internal |
| 9 | BR-LS-M | Outer Lock Set for Magnor Pole |
| 10 | CPT712 | Handle Grip For Telepole |
| 11 | CPT413 | Wishbone Pool (X) Clip Single |
| 12 | CPT813 | Wishbone Pool (V) Clip – Single |
| 13 | CPT420 | Wishbone Pool (X) Clip 20pk |
| 14 | CPT820 | Wishbone Pool (V) Clip – 20pk |
| 15 | CPV267 | Spring Kwiksnap Aussie Gold |
| 16 | CPV502 | Split Pin – Vacuum Handle |
| 17 | CLC300 | Hose Adaptor – Leaf Canister |
| 18 | CPV785 | Wheel Set (8) – Vacuum Heads |
| 19 | CPV762 | Nut & Bolt – Suits Magnor Handle |
| 20 | MRB150 | Replacement Bag – Leaf Canister |
| 21 | CPR511 | Nut & Bolt Replacement Leaf Rake/Scoop |
| 22 | MRB250 | Replacement Bag – Leaf Bagger |
| 23 | MRB200 | Leaf Canister Basket |
| 24 | BR-CSL | Cam Set for Pole - Dark Blue |



Miscellaneous

| | | |
|---|--------|---|
| 1 | MPC020 | Tank O-ring – VEF Pump & Filter Combo |
| 2 | MPC060 | Filter Pump Hose for 3/4 HP System |
| 3 | MPC120 | Filter Pump Hose for 1/2 HP System |
| 4 | MPC030 | Strainer Basket – VEF Pump & Filter Combo |
| 5 | CPB158 | Vacuum Hose Adapter |
| 6 | CPB157 | Bestways Hose Conversion Kit |
| 7 | CPB164 | Intex Hose Connectors - 2 Pack |





Sales and order enquires

BRENDALE

27 Strathwyn Street
Brendale QLD 4500

T 1300 366 020

F 1300 366 025

E sales@poolsystems.com.au

SEVENTEEN MILE ROCKS

136 Bluestone Circuit
Seventeen Mile Rocks QLD 4073

T 1300 677 100

F 1300 677 200

E salesmr@poolsystems.com.au

GOLD COAST

Unit 3, 1 Crown Court,
Varsity Lakes QLD 4227

T 07 5522 0226

F 07 5522 0955

E sales@poolsystems.com.au

VIC

Unit 5, 120 Rodeo Drive
Dandenong South VIC 3157

T 1300 366 020

F 1300 366 025

E sales@poolsystems.com.au

NSW

Unit 2, 29 Crescent Street,
Granville NSW 2142

T 1300 366 020

F 1300 366 025

E sales@poolsystems.com.au

SA

46 King William Street,
Kent Town SA 5067

T 1300 366 020

F 1300 366 025

E sales@poolsystems.com.au

Distributors:

WESTERN AUSTRALIA

Austral Pool Solutions

T 08 9240 5600

NEW ZEALAND

Austral Pool & Spa Products

T +61 9 570 9570

www.poolsystems.com.au